



Small Package PFM Control Step-Up DC/DC Converter

ZS9117 Series

■ INTRODUCTION

The ZS9117 Series is a CMOS PFM-control step-up switching DC/DC converter. The PFM controller allows the duty ratio to be automatically switched according to the load (light load: 66%, high output current: 78%), enabling products with a low ripple over a wide range, high efficiency, and high output current. With the ZS9117 Series, a step-up switching DC/DC converter can be configured by using an external coil, capacitor, and diode. The built-in MOSFET is turned off by a protection circuit when the voltage at the LX pin exceeds the limit to prevent it from being damaged. This feature, along with the mini package and low current consumption, makes the ZS9117

Series ideal for applications such as the power supply unit of portable equipment.

■ APPLICATIONS

- ☞ Digital cameras
- ☞ Electronic notebooks and PDAs
- ☞ Portable CD/MD players

■ BLOCK DIAGRAM

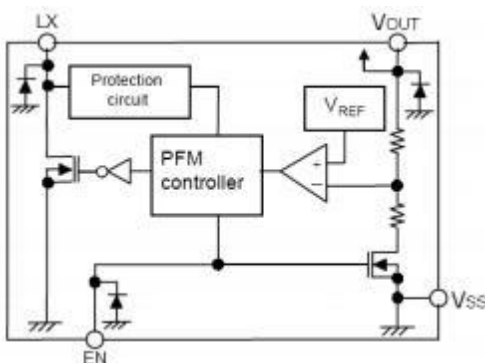

■ FEATURES

- ☞ Low voltage operation: Startup at 0.9 V min. ($I_{OUT} = 1 \text{ mA}$) guaranteed
- ☞ Duty ratio: 66/78%, built in auto switching type PFM controller
- ☞ External parts: Coil, capacitor, diode
- ☞ Output voltage: Settable to between 1.8V to 6.0 V in 0.1 V steps
- ☞ Accuracy of $\pm 2\%$
- ☞ High efficiency: $\pm 85\%$ (typ.)
- ☞ Standard function (product type A)
- ☞ Shutdown function (product type C,D)
- ☞ External transistor type available (product type B、D)

- ☞ Cameras, video equipment,
- ☞ Communications equipment
- ☞ Power supply for microcomputers

☞ DEVICE INFORMATION:

ZS9117 ①②③④

DESIGNATOR	SYMBOL	DESCRIPTION
①	A	Standard LX
	B	Standard EXT
	C	With shutdown, LX
	D	With shutdown, EXT
②③	Integer	Output Voltage (1.8~6.0) e.g.: 3.0V=②:3; ③:0
④	T3/T5	Package: SOT-23-3/5L
	R/H	Package: SOT-89-3/5L
	L	Package: TO-92

Pin configuration

SOT-23-3L
Top view

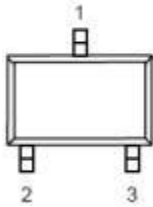

Table 1 ZS9117A Series (SOT-23-3L PKG)

PIN NO.	PIN NAME	FUNCTION
1	V_{OUT}	Output voltage pin
2	V_{SS}	GND pin
3	LX	External inductor connection pin

Table 2 ZS9117B Series (SOT-23-3L PKG)

PIN NO.	PIN NAME	FUNCTION
1	V_{OUT}	Output voltage pin
2	V_{SS}	GND pin
3	EXT	External transistor connection pin

Table 3 ZS9117C Series (SOT-23-5L PKG)

PIN NO.	PIN NAME	FUNCTION
1	EN	Shutdown pin “H”: Normal operation “L”: Step-up stopped
2	V_{OUT}	Output voltage pin
3	NC	(N.C.)
4	V_{SS}	GND pin
5	LX	External inductor connection pin

SOT-23-5L
Top view

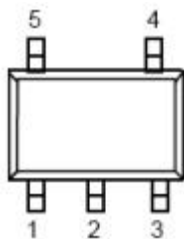

Table 4 ZS9117D Series (SOT-23-5L PKG)

PIN NO.	PIN NAME	FUNCTION
1	EN	Shutdown pin “H”: Normal operation “L”: Step-up stopped
2	V_{OUT}	Output voltage pin
3	NC	(N.C.)
4	V_{SS}	GND pin
5	EXT	External transistor connection pin

Table 5 ZS9117A Series (SOT-89-3L PKG)

PIN NO.	PIN NAME	FUNCTION
1	V_{SS}	GND pin
2	V_{OUT}	Output voltage pin
3	LX	External inductor connection pin

SOT-89-3L
Top view

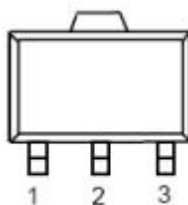

Table 6 ZS9117B Series (SOT-89-3L PKG)

PIN NO.	PIN NAME	FUNCTION
1	V_{SS}	GND pin
2	V_{OUT}	Output voltage pin
3	EXT	External transistor connection pin

Table 7 ZS9117C Series (SOT-89-5L PKG)

PIN NO.	PIN NAME	FUNCTION
1	NC	(N.C.)
2	V _{OUT}	Output voltage pin
3	EN	Shutdown pin “H”: Normal operation “L”: Step-up stopped
4	LX	External inductor connection pin
5	V _{SS}	GND pin



Table 8 ZS9117D Series (SOT-89-5L PKG)

PIN NO.	PIN NAME	FUNCTION
1	NC	(N.C.)
2	V _{OUT}	Output voltage pin
3	EN	Shutdown pin “H”: Normal operation “L”: Step-up stopped
4	EXT	External transistor connection pin
5	V _{SS}	GND pin

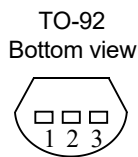

Table 9 ZS9117A Series (TO-92 PKG)

PIN NO.	PIN NAME	FUNCTION
1	V _{SS}	GND pin
2	V _{OUT}	Output voltage pin
3	LX	External inductor connection pin

■ ABSOLUTE MAXIMUM RATINGS (Unless otherwise specified, Ta=25°C)

PARAMETER	SYMBOL	RATINGS	UNITS	
V _{OUT} pin voltage	V _{OUT}	V _{SS} -0.3 ~ V _{SS} +8	V	
EN pin voltage	EN	V _{SS} -0.3 ~ V _{SS} +8	V	
LX pin voltage	V _{LX}	V _{SS} -0.3 ~ V _{SS} +8	V	
LX pin current	I _{LX}	1000	mA	
Power dissipation	SOT-23-3L	PD	400	mW
	SOT-23-5L		400	mW
	SOT-89-3/5L		600	mW
	TO-92		500	mW
Operating temperature	T _{opr}	-40 ~+85	°C	
Storage temperature	T _{stg}	-40 ~+125	°C	
Soldering Temperature & Time	T _{solder}	260°C, 10s		

Electrical Characteristics

(Unless otherwise specified, Ta=25°C)

PARAMETER	SYMBOL	CONDITIONS	MIN	TYP	MAX	UNITS	
Output voltage	V _{OUT}	–	V _{OUT(S)} ×0.98	V _{OUT}	V _{OUT(S)} ×1.02	V	
Input voltage	V _{IN}	–	–	–	6	V	
Operation start voltage	V _{ST1}	I _{OUT} = 1 mA	–	–	0.9	V	
Oscillation start voltage	V _{ST2}	No external parts, voltage applied to V _{OUT} LX pulled up to V _{OUT} via 300Ω resistor	–	–	0.8	V	
Current consumption 1	I _{SS1}	V _{OUT} =0.95×V _{OUT}	V _{OUT} : 3.0V	–	20	40	μA
			V _{OUT} : 5.0V	–	30	60	μA
Current consumption 2	I _{SS2}	V _{OUT} =V _{OUT} +0.5 V	–	6	10	μA	
Current consumption during shutdown	I _{SSS}	V _{EN} = 0 V	–	–	1.0	μA	
Switching current	I _{SW}	V _{LX} = 0.4 V	100	200	–	mA	
Switching transistor leakage current	I _{SWQ}	No external parts, V _{LX} =V _{OUT} =8 V, V _{EN} = 0 V	–	–	1.0	μA	
Line regulation	ΔV _{OUT1}	V _{IN} = 0.4×V _{OUT} [~] 0.6×V _{OUT}	–	20	50	mV	
Load regulation	ΔV _{OUT2}	I _{OUT} = 10 μA ~ 50mA	–	20	50	mV	
Maximum Oscillation frequency	f _{OSC}	V _{OUT} = 0.95×V _{OUT} , measure waveform at LX pin	–	100	–	KHz	
Duty ratio 1	Duty1	V _{OUT} = 0.95×V _{OUT} , measure waveform at LX pin	70	78	85	%	
Duty ratio 2	Duty2	Measure waveform at LX pin with light load	–	66	–	%	
Efficiency	EFFI	–	–	85	–	%	
Shutdown pin input voltage	V _{SH}	V _{OUT} =0.95×V _{OUT} , judge oscillation at LX pin	0.75	–	–	V	
	V _{SL1}	V _{OUT} = 0.95×V _{OUT} , judgestop at LX pin	–	–	0.3	V	
Shutdown pin input current	I _{SH}	V _{EN} = 6V	-0.1	–	0.1	μA	
	I _{SL}	V _{EN} = 0V	-0.1	–	0.1	μA	

Remark: V_{IN} = V_{OUT(S)} × 0.6 applied, I_{OUT} = V_{OUT(S)} / 250 Ω

Shutdown function built-in type: EN pin is connected to V_{OUT}

V_{ST1} only is suitable for SZS9117A/C

V_{OUT(S)} specified above is the set output voltage value, and V_{OUT} is the typical value of the actual output voltage.

Typical Characteristics

STANDARD CIRCUITS

Component: Inductor: 47uH(Sumida)

Capacitor: 47uF/16V(Tantalum)

NMOS: ZS3400、ZS2302

Base Resistor(Rb): 1K Ω

Diode: B5817WS、B5819WS

Transistor: 2SC1766、2SD965

1、 ZS9117A Circuits:

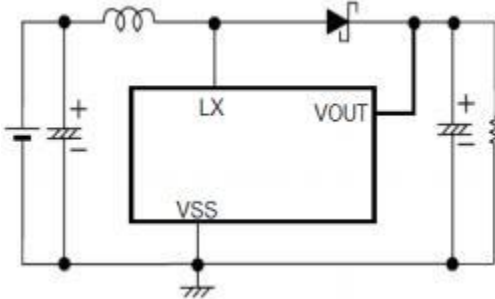

2、 ZS9117C Circuits:

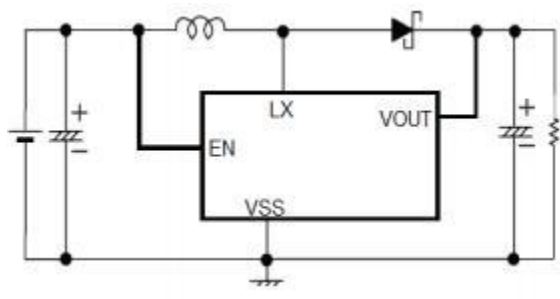

3、 ZS9117B Circuits:

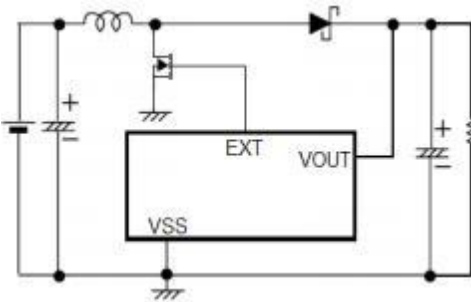

4、 ZS9117D Circuits:

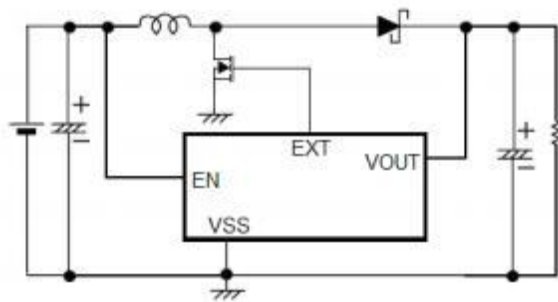

TYPICAL PERFORMANCE CHARACTERISTICS

1. ZS9117A30R:

a、 V_{OUT} vs. I_{OUT} :

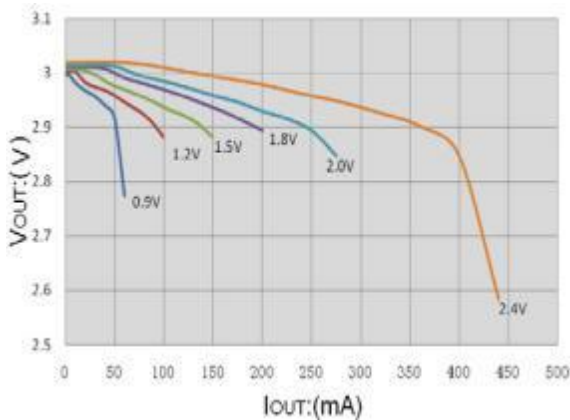

b、 Efficiency vs. I_{OUT} :

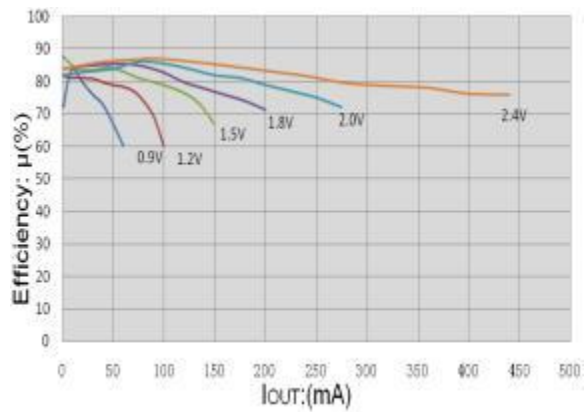

Typical Characteristics

2. ZS9117 A33R:

a、 V_{OUT} vs. I_{OUT} :

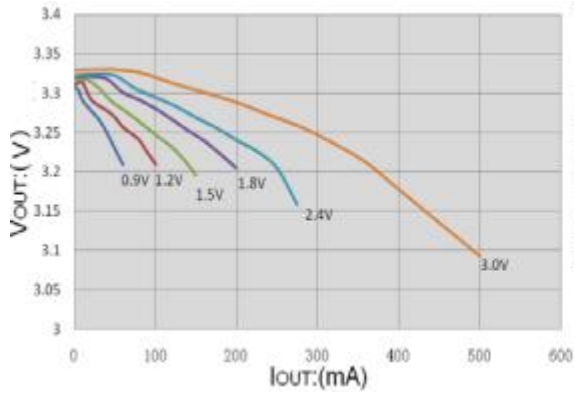

b、Efficiency vs. I_{OUT} :

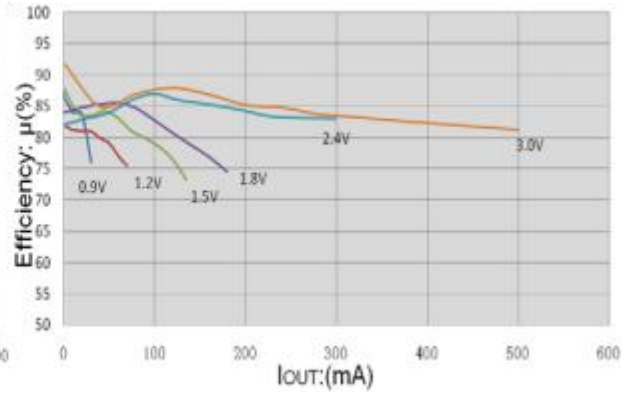

3. ZS9117A50R:

a、 V_{OUT} vs. I_{OUT} :

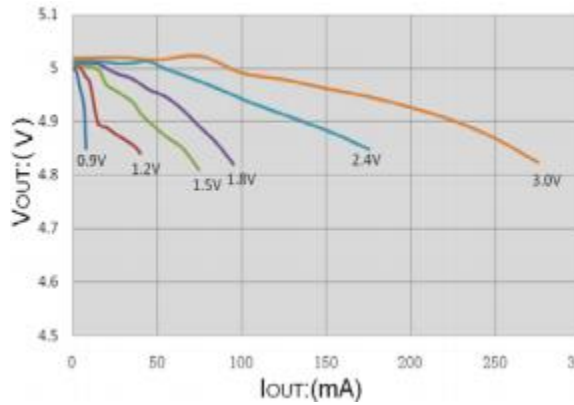

b、Efficiency vs. I_{OUT} :

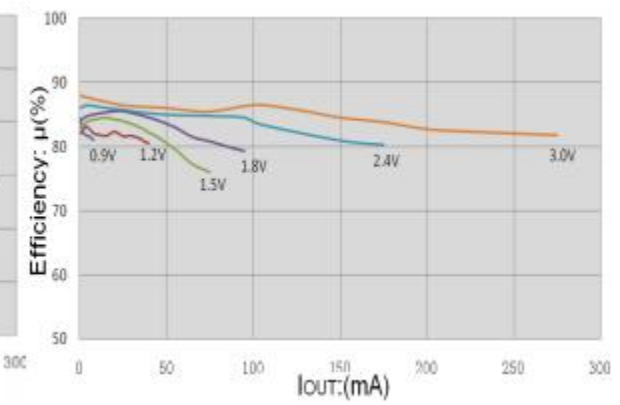

4. ZS9117B36R:

a、 V_{OUT} vs. I_{OUT} :

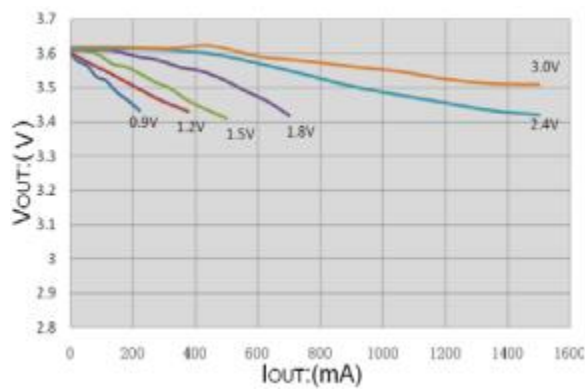

b、Efficiency vs. I_{OUT} :

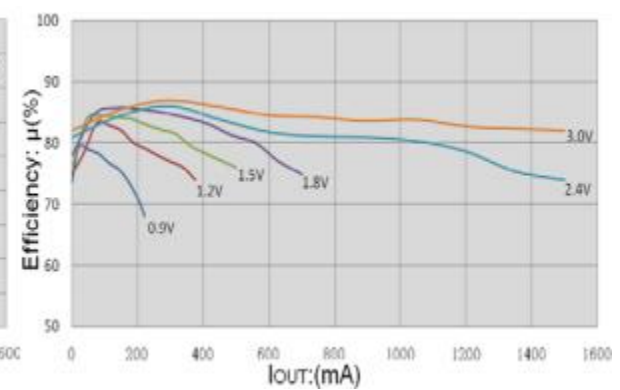

Typical Characteristics

5. ZS9117B50R:

a、 V_{out} vs. I_{out} :

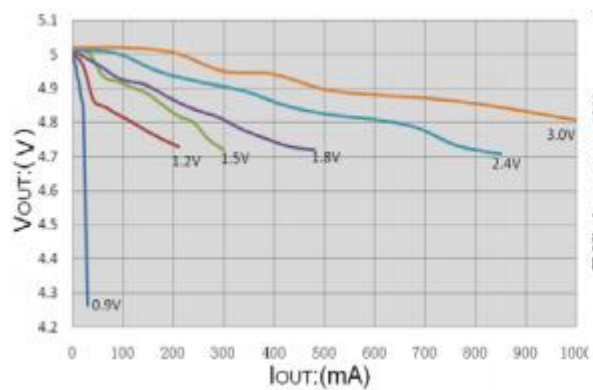

b、Efficiency vs. I_{out} :

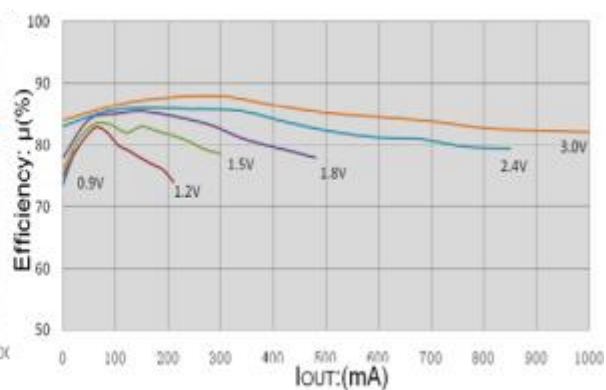

SOT-23-3L Package Outline Dimensions

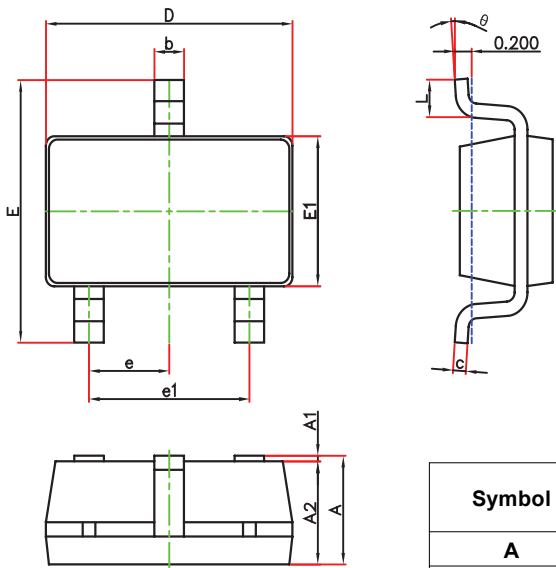

Symbol	Dimensions In Millimeters		Dimensions In Inches	
	Min.	Max.	Min.	Max.
A	1.050	1.250	0.041	0.049
A1	0.000	0.100	0.000	0.004
A2	1.050	1.150	0.041	0.045
b	0.300	0.500	0.012	0.020
c	0.100	0.200	0.004	0.008
D	2.820	3.020	0.111	0.119
E	1.500	1.700	0.059	0.067
E1	2.650	2.950	0.104	0.116
e	0.950(BSC)		0.037(BSC)	
e1	1.800	2.000	0.071	0.079
L	0.300	0.600	0.012	0.024
θ	0°	8°	0°	8°

SOT-23-3L Suggested pad Layout

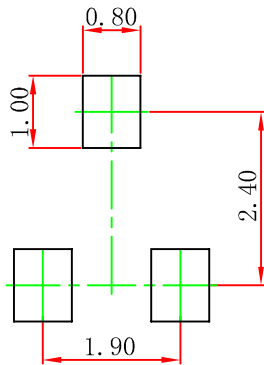

- Note:
1. Controlling dimension: in millimeters.
 2. General tolerance: $\pm 0.05\text{mm}$.
 3. The pad layout is for reference purposes only.

SOT-89-3L Package Outline Dimensions

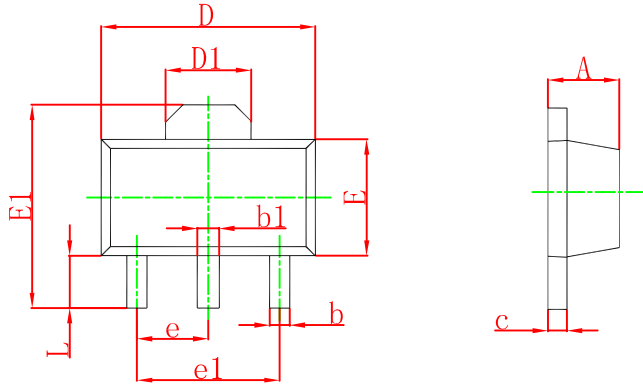

Symbol	Dimensions In Millimeters		Dimensions In Inches	
	Min.	Max.	Min.	Max.
A	1.400	1.600	0.055	0.063
b	0.320	0.520	0.013	0.197
b1	0.400	0.580	0.016	0.023
c	0.350	0.440	0.014	0.017
D	4.400	4.600	0.173	0.181
D1	1.550 REF		0.061 REF	
E	2.300	2.600	0.091	0.102
E1	3.940	4.250	0.155	0.167
e	1.500 TYP		0.060 TYP	
e1	3.000 TYP		0.118 TYP	
L	0.900	1.200	0.035	0.047

SOT-89-3L Suggested Pad Layout

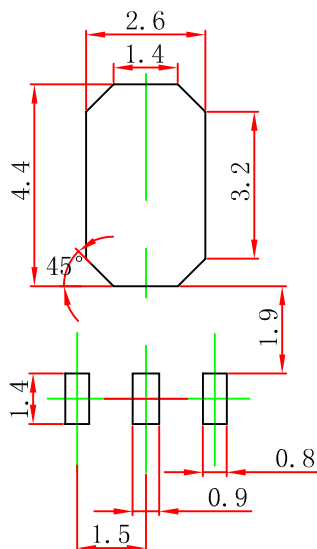

Note:
 1. Controlling dimension: in millimeters.
 2. General tolerance: ± 0.05 mm.
 3. The pad layout is for reference purposes only.

SOT-23-5L Package Outline Dimensions

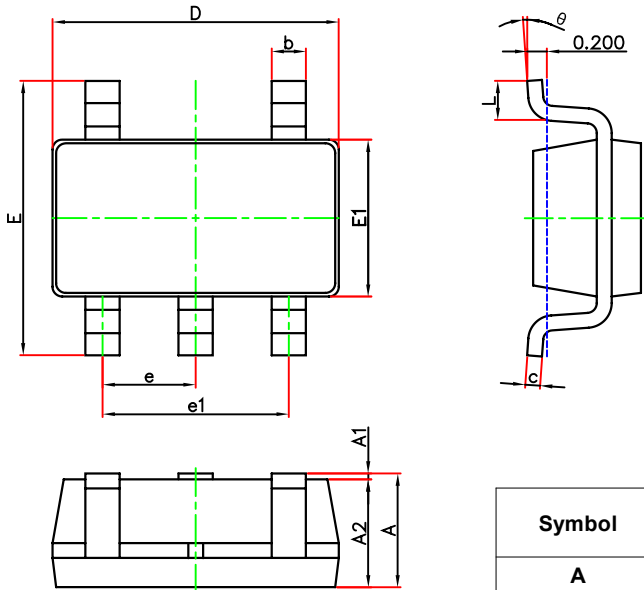

Symbol	Dimensions In Millimeters		Dimensions In Inches	
	Min.	Max.	Min.	Max.
A	1.050	1.250	0.041	0.049
A1	0.000	0.100	0.000	0.004
A2	1.050	1.150	0.041	0.045
b	0.300	0.500	0.012	0.020
c	0.100	0.200	0.004	0.008
D	2.820	3.020	0.111	0.119
E	1.500	1.700	0.059	0.067
E1	2.650	2.950	0.104	0.116
e	0.950(BSC)		0.037(BSC)	
e1	1.800	2.000	0.071	0.079
L	0.300	0.600	0.012	0.024
θ	0°	8°	0°	8°

SOT-23-5L Suggested Pad Layout

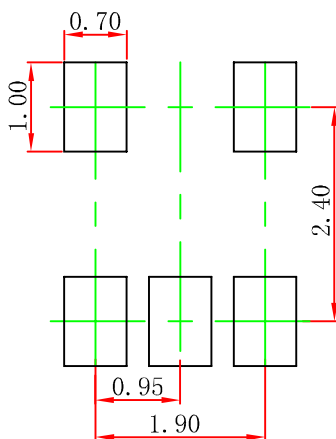

Note:

1. Controlling dimension; in millimeters.
2. General tolerance $\pm 0.05\text{mm}$.
3. The pad layout is for reference purposes only.

- SOT-89-5L

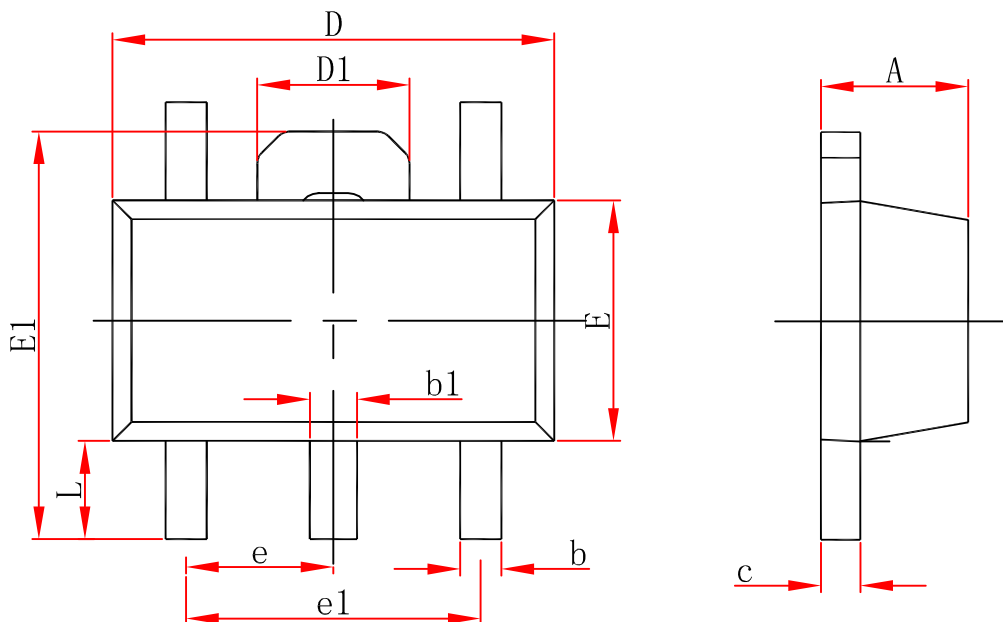

Symbol	Dimensions In Millimeters		Dimensions In Inches	
	Min.	Max.	Min.	Max.
A	1.400	1.600	0.055	0.063
b	0.320	0.520	0.013	0.020
b1	0.380	0.580	0.015	0.023
c	0.350	0.440	0.014	0.017
D	4.400	4.600	0.173	0.181
D1	1.550 REF.		0.061 REF.	
E	2.300	2.600	0.091	0.102
E1	3.940	4.250	0.155	0.167
e	1.500 TYP.		0.060 TYP.	
e1	3.000 TYP.		0.118 TYP.	
L	0.900	1.200	0.035	0.047

TO-92 package Outline Dimensions

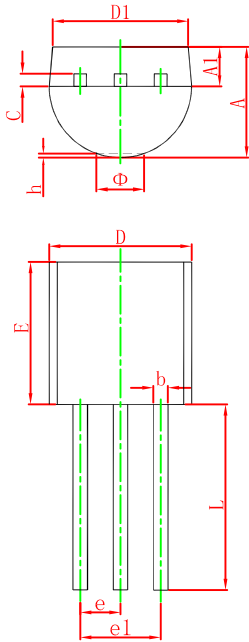

Symbol	Dimensions In Millimeters		Dimensions In Inches	
	Min.	Max.	Min.	Max.
A	3.300	3.700	0.130	0.146
A1	1.100	1.400	0.043	0.055
b	0.380	0.550	0.015	0.022
c	0.360	0.510	0.014	0.020
D	4.400	4.700	0.173	0.185
D1	3.430		0.135	
E	4.300	1.400	0.169	0.185
e	1.270 TYP		0.050 TYP	
e1	2.440	2.640	0.096	0.104
L	14.100	14.500	0.555	0.571
Φ		1.600		0.063
h	0.000	0.380	0.000	0.015

TO-92 suggested pad Layout

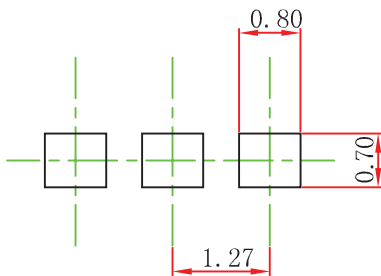

Note:

1. Controlling dimension: In millimeters.
2. General tolerance: ± 0.05 mm.
3. The pad layout is for reference purposes only.

DISCLAIMER

IMPORTANT NOTICE, PLEASE READ CAREFULLY

The information in this data sheet is intended to describe the operation and characteristics of our products. ZS has the right to make any modification, enhancement, improvement, correction or other changes to any content in this data sheet, including but not limited to specification parameters, circuit design and application information, without prior notice.

Any person who purchases or uses ZS products for design shall: 1. Select products suitable for circuit application and design; 2. Design, verify and test the rationality of circuit design; 3. Procedures to ensure that the design complies with relevant laws and regulations and the requirements of such laws and regulations. ZS makes no warranty or representation as to the accuracy or completeness of the information contained in this data sheet and assumes no responsibility for the application or use of any of the products described in this data sheet.

Without the written consent of ZS, this product shall not be used in occasions requiring high quality or high reliability, including but not limited to the following occasions: medical equipment, automotive electronics, military facilities and aerospace. ZS shall not be responsible for casualties or property losses caused by abnormal use or application of this product.