

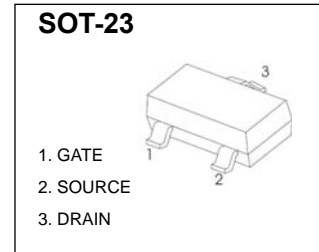

# SOT-23 Plastic-Encapsulate MOSFETS

## ZS3400A N-Channel Enhancement Mode Field Effect Transistor

$V_{(BR)DSS}$	$R_{DS(on)MAX}$	$I_D$
30V	32mΩ@10V	5.8A
	38mΩ@4.5V	
	45mΩ@2.5V	



### FEATURE

- High dense cell design for extremely low  $R_{DS(ON)}$
- Exceptional on-resistance and maximum DC current capability

### APPLICATION

- Load/Power Switching
- Interfacing Switching

### MARKING: R0<sub>A</sub>

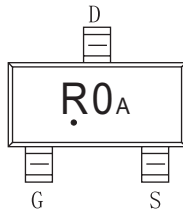

R0<sub>A</sub> = Device code  
 Solid dot = Green molding compound device.

### Equivalent Circuit

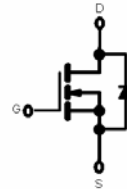

### Maximum ratings ( $T_a=25^{\circ}C$ unless otherwise noted)

Parameter	Symbol	Value	Unit
Drain-Source Voltage	$V_{DS}$	30	V
Gate-Source Voltage	$V_{GS}$	±12	V
Continuous Drain Current	$I_D$	5.8	A
Drain Current-Pulsed <sup>①</sup>	$I_{DM}$	30	A
Power Dissipation	$P_D$	400	mW
Thermal Resistance from Junction to Ambient	$R_{\theta JA}$	313	°C/W
Operation Junction and Storage Temperature Range	$T_J, T_{STG}$	-55~+150	°C

## MOSFET ELECTRICAL CHARACTERISTICS

$T_a=25\text{ }^\circ\text{C}$  unless otherwise specified

Parameter	Symbol	Test Condition	Min	Typ	Max	Unit
<b>Off Characteristics</b>						
Drain-source breakdown voltage	$V_{(BR)DSS}$	$V_{GS} = 0V, I_D = 250\mu A$	30			V
Zero gate voltage drain current	$I_{DSS}$	$V_{DS} = 24V, V_{GS} = 0V, T_J = 25\text{ }^\circ\text{C}$			1	$\mu A$
		$V_{DS} = 24V, V_{GS} = 0V, T_J = 125\text{ }^\circ\text{C}$			1	mA
Gate-source leakage current	$I_{GSS}$	$V_{GS} = \pm 12V, V_{DS} = 0V$			$\pm 100$	nA
<b>On characteristics<sup>②</sup></b>						
Drain-source on-resistance	$R_{DS(on)}$	$V_{GS} = 10V, I_D = 5.8A$		23	32	m $\Omega$
		$V_{GS} = 4.5V, I_D = 5A$		24	38	m $\Omega$
		$V_{GS} = 2.5V, I_D = 4A$		30	45	m $\Omega$
Forward transconductance	$g_{FS}$	$V_{DS} = 5V, I_D = 5A$	8			S
Gate threshold voltage	$V_{GS(th)}$	$V_{DS} = V_{GS}, I_D = 250\mu A$	0.7	0.9	1.4	V
<b>Dynamic Characteristics<sup>③</sup></b>						
Input capacitance	$C_{iss}$	$V_{DS} = 15V, V_{GS} = 0V, f = 1\text{MHz}$		825	1155	pF
Output capacitance	$C_{oss}$			108	120	pF
Reverse transfer capacitance	$C_{riss}$			84	100	pF
Gate resistance	$R_g$	$V_{DS} = 0V, V_{GS} = 0V, f = 1\text{MHz}$		3.6		$\Omega$
<b>Switching Characteristics<sup>③</sup></b>						
Turn-on delay time	$t_{d(on)}$	$V_{GS} = 10V, V_{DS} = 15V,$ $R_L = 2.7\Omega, R_{GEN} = 3\Omega$		3.3	5	ns
Turn-on rise time	$t_r$			4.8	7	ns
Turn-off delay time	$t_{d(off)}$			26	40	ns
Turn-off fall time	$t_f$			4	6	ns
Total Gate Charge	$Q_g$	$V_{DS} = 15V, I_D = 5A,$ $V_{GS} = 6V$		10		nC
Gate-Source Charge	$Q_{gs}$			1.6		nC
Gate-Drain Charge	$Q_{gd}$			3.1		nC
<b>Drain-source diode characteristics and maximum ratings</b>						
Diode forward voltage <sup>②</sup>	$V_{SD}$	$I_S = 1A, V_{GS} = 0V$			1	V
Continuous drain-source diode forward current	$I_S$				5.8	A
Pulsed drain-source diode forward current <sup>①</sup>	$I_{SM}$				30	A

**Note :**

1. Repetitive Rating : Pulse width limited by maximum junction temperature.
2. Pulse Test : Pulse Width  $\leq 300\mu s$ , Duty Cycle  $\leq 2\%$ .
3. Guaranteed by design, not subject to production testing.

# Typical Characteristics

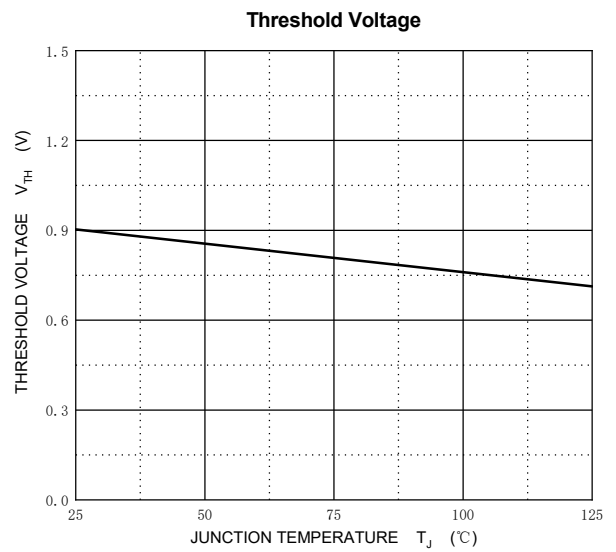
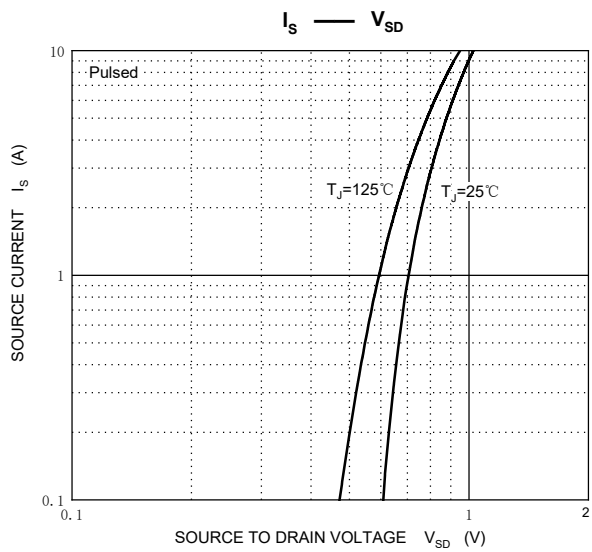
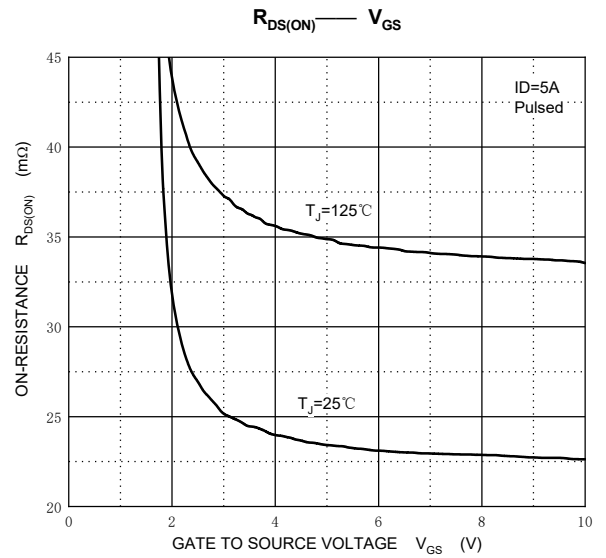
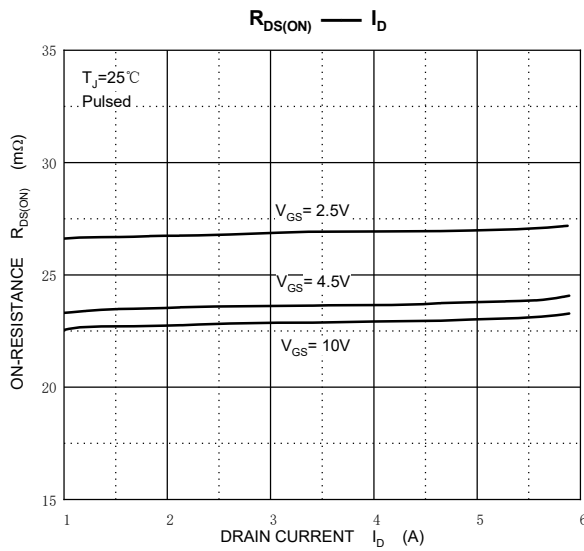
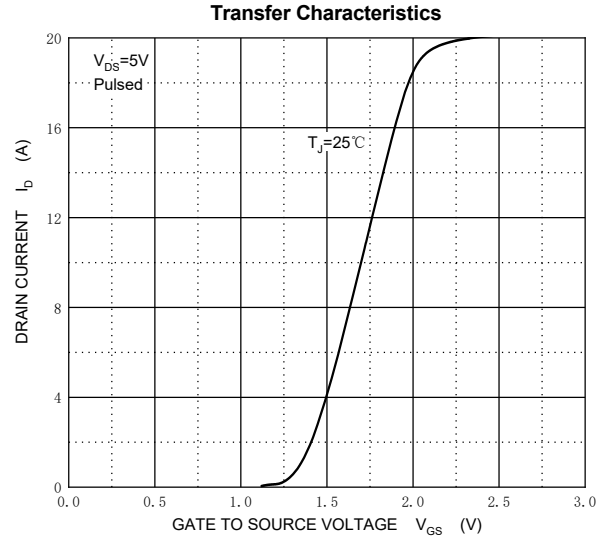
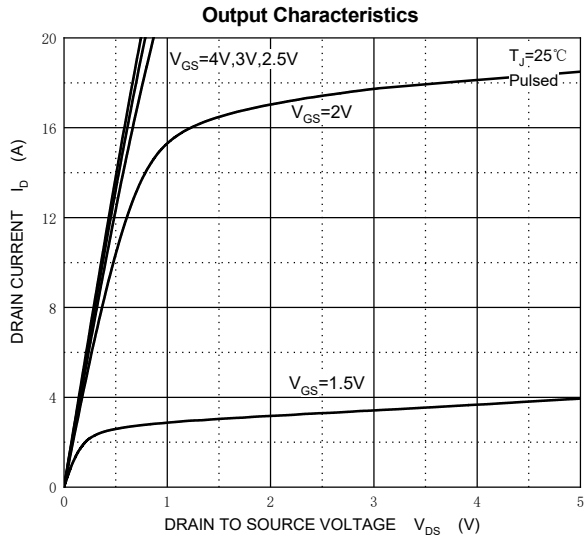

## SOT-23 Package Outline Dimensions

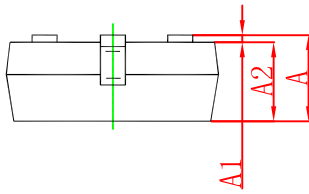
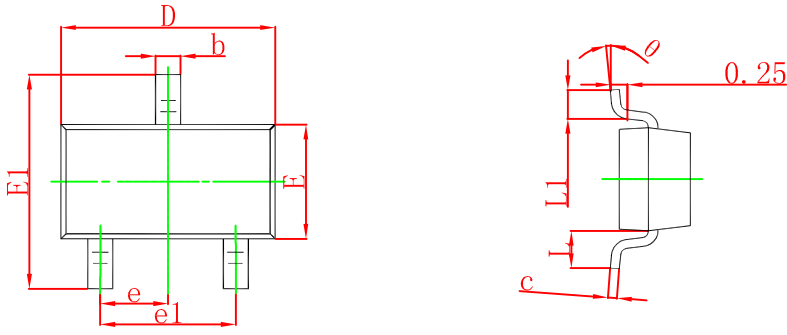

Symbol	Dimensions In Millimeters		Dimensions In Inches	
	Min	Max	Min	Max
A	0.900	1.150	0.035	0.045
A1	0.000	0.100	0.000	0.004
A2	0.900	1.050	0.035	0.041
b	0.300	0.500	0.012	0.020
c	0.080	0.150	0.003	0.006
D	2.800	3.000	0.110	0.118
E	1.200	1.400	0.047	0.055
E1	2.250	2.550	0.089	0.100
e	0.950 TYP		0.037 TYP	
e1	1.800	2.000	0.071	0.079
L	0.550 REF		0.022 REF	
L1	0.300	0.500	0.012	0.020
θ	0°	8°	0°	8°

## SOT-23 Suggested Pad Layout

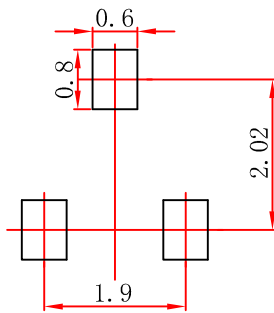

- Note:
1. Controlling dimension: in millimeters.
  2. General tolerance:  $\pm 0.05\text{mm}$ .
  3. The pad layout is for reference purposes only.

# SOT-23 Tape and Reel

## SOT-23 Embossed Carrier Tape

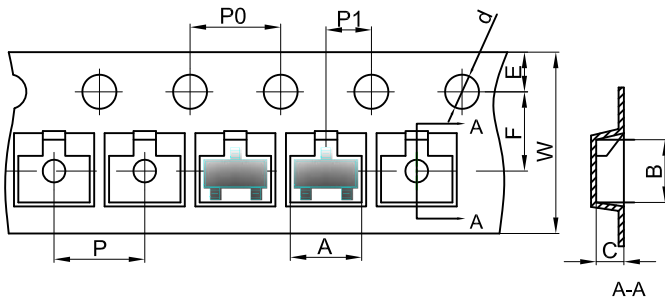

### Packaging Description:

SOT-23 parts are shipped in tape. The carrier tape is made from a dissipative (carbon filled) polycarbonate resin. The cover tape is a multilayer film (Heat Activated Adhesive in nature) primarily composed of polyester film, adhesive layer, sealant, and anti-static sprayed agent. These reeled parts in standard option are shipped with 3,000 units per 7" or 17.8cm diameter reel. The reels are clear in color and is made of polystyrene plastic (anti-static coated).

Dimensions are in millimeter

Pkg type	A	B	C	d	E	F	P0	P	P1	W
SOT-23	3.15	2.77	1.22	Ø1.50	1.75	3.50	4.00	4.00	2.00	8.00

## SOT-23 Tape Leader and Trailer

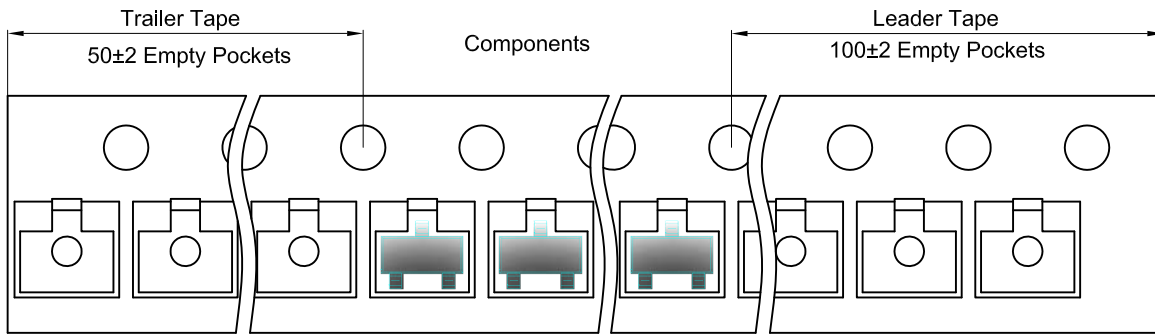

## SOT-23 Reel

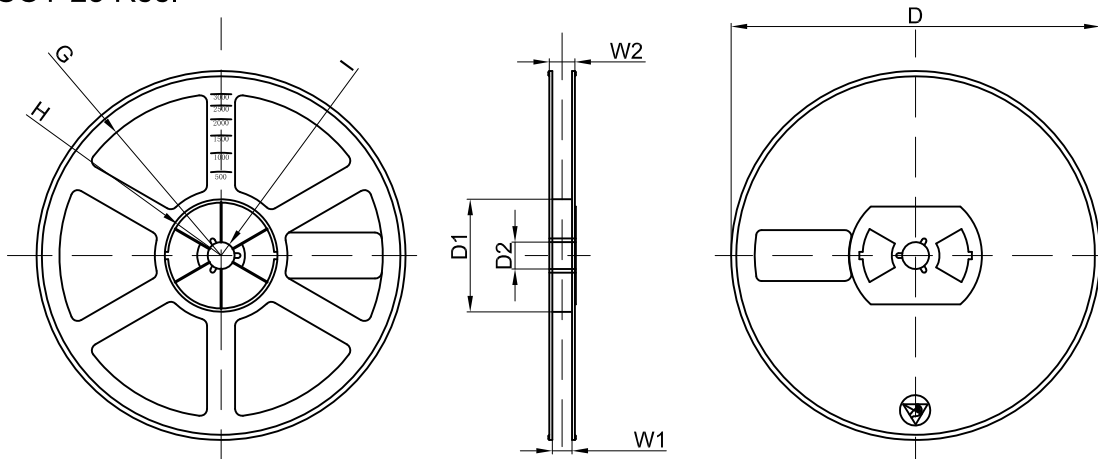

Dimensions are in millimeter

Reel Option	D	D1	D2	G	H	I	W1	W2
7"Dia	Ø178.00	54.40	13.00	R78.00	R25.60	R6.50	9.50	12.30

REEL	Reel Size	Box	Box Size(mm)	Carton	Carton Size(mm)	G.W.(kg)
3000 pcs	7 inch	30,000 pcs	203×203×195	120,000 pcs	438×438×220	