



SOT-363 Plastic-Encapsulate Transistors

MMDT5451 DUAL TRANSISTOR (NPN+PNP)

FEATURES

- Epitaxial Planar Die Construction
- Ideal for low Power Amplification and Switching
- One 5551(NPN), one 5401(PNP)

MRKING:KNM

MAXIMUM RATINGS NPN 5551 ($T_a=25^{\circ}\text{C}$ unless otherwise noted)

Symbol	Parameter	Value	Units
V_{CBO}	Collector- Base Voltage	180	V
V_{CEO}	Collector-Emitter Voltage	160	V
V_{EBO}	Emitter-Base Voltage	6	V
I_C	Collector Current -Continuous	0.2	A
P_C	Collector Power Dissipation	0.2	W
$R_{\theta JA}$	Thermal Resistance, Junction to Ambient	625	$^{\circ}\text{C}/\text{W}$
T_J, T_{stg}	Operation Junction and Storage Temperature Range	-55~+150	$^{\circ}\text{C}$

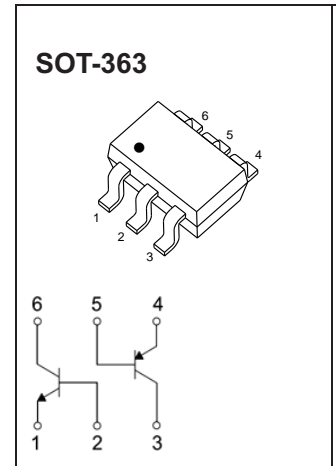

ELECTRICAL CHARACTERISTICS NPN 5551 ($T_a=25^{\circ}\text{C}$ unless otherwise specified)

Parameter	Symbol	Test conditions	Min	Typ	Max	Unit
Collector-base breakdown voltage	$V_{(BR)CBO}$	$I_C=100\mu\text{A}, I_E=0$	180			V
Collector-emitter breakdown voltage	$V_{(BR)CEO}$	$I_C=1\text{mA}, I_B=0$	160			V
Emitter-base breakdown voltage	$V_{(BR)EBO}$	$I_E=10\mu\text{A}, I_C=0$	6			V
Collector cut-off current	I_{CBO}	$V_{CB}=120\text{V}, I_E=0$			0.05	μA
Emitter cut-off current	I_{EBO}	$V_{EB}=4\text{V}, I_C=0$			0.05	μA
DC current gain	h_{FE1}	$V_{CE}=5\text{V}, I_C=1\text{mA}$	80			
	h_{FE2}	$V_{CE}=5\text{V}, I_C=10\text{mA}$	100		300	
	h_{FE3}	$V_{CE}=5\text{V}, I_C=50\text{mA}$	30			
Collector-emitter saturation voltage	$V_{CE(sat)}$	$I_C=10\text{mA}, I_B=1\text{mA}$			0.15	V
		$I_C=50\text{mA}, I_B=5\text{mA}$			0.2	V
Base-emitter saturation voltage	$V_{BE(sat)}$	$I_C=10\text{mA}, I_B=1\text{mA}$			1	V
		$I_C=50\text{mA}, I_B=5\text{mA}$			1	V
Output Capacitance	C_{obo}	$V_{CB} = 10\text{V}, f = 1.0\text{MHz}, I_E = 0$			6.0	pF
Current Gain-Bandwidth Product	f_T	$V_{CE} = 10\text{V}, I_C = 10\text{mA}, f = 100\text{MHz}$	100		300	MHz
Noise Figure	NF	$V_{CE}= 5.0\text{V}, I_C = 200\mu\text{A}, R_S = 1.0\text{k}\Omega, f = 1.0\text{kHz}$			8.0	dB

MAXIMUM RATINGS PNP 5401 (T_a=25°C unless otherwise noted)

Symbol	Parameter	Value	Units
V _{CB0}	Collector- Base Voltage	-160	V
V _{CEO}	Collector-Emitter Voltage	-150	V
V _{EBO}	Emitter-Base Voltage	-5	V
I _C	Collector Current -Continuous	-0.2	A
P _C	Collector Power Dissipation	0.2	W
R _{θJA}	Thermal Resistance, Junction to Ambient	625	°C/W
T _J ,T _{stg}	Operation Junction and Storage Temperature Range	-55~+150	°C

ELECTRICAL CHARACTERISTICS PNP 5401 (T_a=25°C unless otherwise specified)

Parameter	Symbol	Test conditions	Min	Typ	Max	Unit
Collector-base breakdown voltage	V _{(BR)CBO}	I _C =-100μA, I _E =0	-160			V
Collector-emitter breakdown voltage	V _{(BR)CEO}	I _C =-1mA, I _B =0	-150			V
Emitter-base breakdown voltage	V _{(BR)EBO}	I _E =-10μA, I _C =0	-5			V
Collector cut-off current	I _{CBO}	V _{CB} =-120V, I _E =0			-50	nA
Emitter cut-off current	I _{EBO}	V _{EB} =-3V, I _C =0			-50	nA
DC current gain	h _{FE1}	V _{CE} =-5V, I _C =-1mA	50			
	h _{FE2}	V _{CE} =-5V, I _C =-10mA	100		300	
	h _{FE3}	V _{CE} =-5V, I _C =-50mA	50			
Collector-emitter saturation voltage	V _{CE(sat)}	I _C =-10mA, I _B =-1mA			-0.2	V
		I _C =-50mA, I _B =-5mA			-0.5	V
Base-emitter saturation voltage	V _{BE(sat)}	I _C =-10mA, I _B =-1mA			-1	V
		I _C =-50mA, I _B =-5mA			-1	V
Output Capacitance	C _{obo}	V _{CB} =-10V, f = 1.0MHz, I _E = 0			6.0	pF
Current Gain-Bandwidth Product	f _T	V _{CE} =-10V, I _C =-10mA, f = 100MHz	100		300	MHz
Noise Figure	NF	V _{CE} =-5.0V, I _C =-200μA, R _S = 10 Ω, f = 1.0kHz			8.0	dB

SOT-363 Package Outline Dimensions

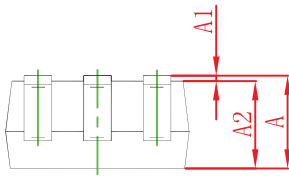
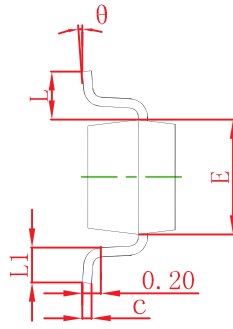
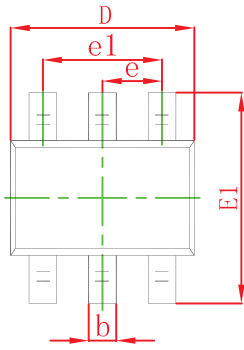

Symbol	Dimensions In Millimeters		Dimensions In Inches	
	Min	Max	Min	Max
A	0.900	1.100	0.035	0.043
A1	0.000	0.100	0.000	0.004
A2	0.900	1.000	0.035	0.039
b	0.150	0.350	0.006	0.014
c	0.100	0.150	0.004	0.006
D	2.000	2.200	0.079	0.087
E	1.150	1.350	0.045	0.053
E1	2.150	2.400	0.085	0.094
e	0.650 TYP		0.026 TYP	
e1	1.200	1.400	0.047	0.055
L	0.525 REF		0.021 REF	
L1	0.260	0.460	0.010	0.018
theta	0°	8°	0°	8°

SOT-363 Suggested Pad Layout

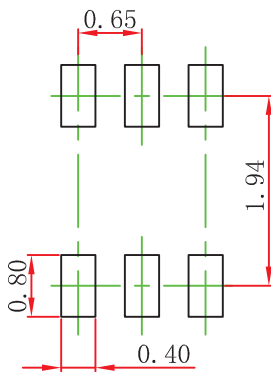

Note:

1. Controlling dimension: in millimeters.
2. General tolerance: $\pm 0.05\text{mm}$.
3. The pad layout is for reference purposes only.

SOT-363 Tape and Reel

SOT-363 Embossed Carrier Tape

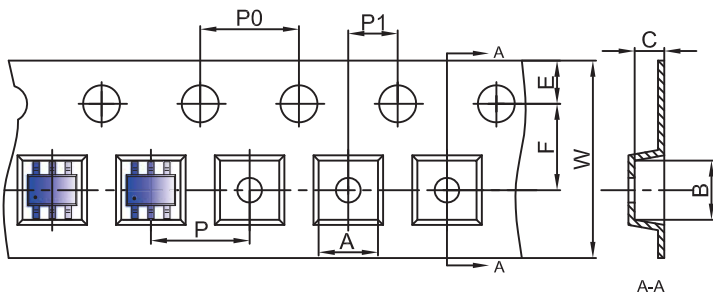

Packaging Description:

SOT-363 parts are shipped in tape. The carrier tape is made from a dissipative (carbon filled) polycarbonate resin. The cover tape is a multilayer film (Heat Activated Adhesive in nature) primarily composed of polyester film, adhesive layer, sealant, and anti-static sprayed agent. These reeled parts in standard option are shipped with 3,000 units per 7" or 17.8cm diameter reel. The reels are clear in color and is made of polystyrene plastic (anti-static coated).

Dimensions are in millimeter										
Pkg type	A	B	C	d	E	F	P0	P	P1	W
SOT-363	2.25	2.55	1.20	Ø1.50	1.75	3.50	4.00	4.00	2.00	8.00

SOT-363 Tape Leader and Trailer

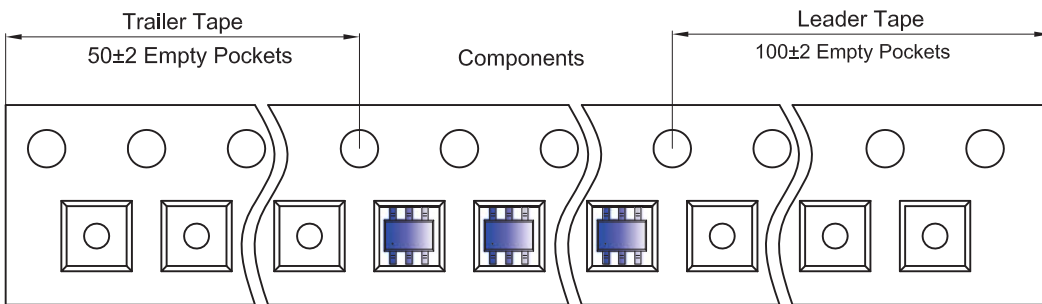

SOT-363 Reel

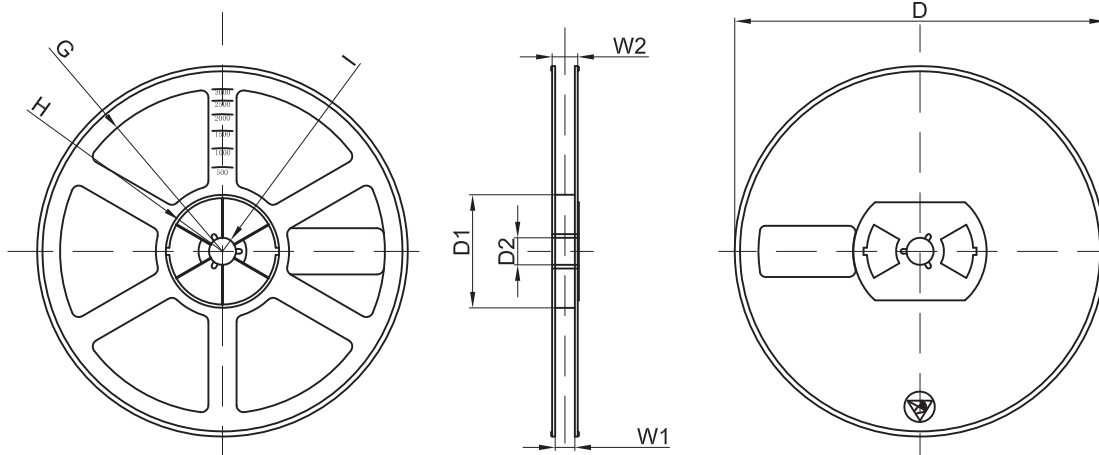

Dimensions are in millimeter								
Reel Option	D	D1	D2	G	H	I	W1	W2
7" Dia	Ø178.00	54.40	13.00	R78.00	R25.60	R6.50	9.50	12.30

REEL	Reel Size	Box	Box Size(mm)	Carton	Carton Size(mm)	G.W.(kg)
3000 pcs	7 inch	45,000 pcs	203×203×195	180,000 pcs	438×438×220	