



# SOT-363 Plastic-Encapsulate Transistors

## MMDT4401 DUAL TRANSISTOR (NPN+NPN)

### FEATURES

- Epitaxial Planar Die Construction
- Ideal for Low Power Amplification and Switching

### MRKING:K2X

### Maximum Ratings (Ta = 25°C unless otherwise specified)

Symbol	Parameter	Value	Units
V <sub>CB0</sub>	Collector-Base Voltage	60	V
V <sub>CE0</sub>	Collector-Emitter Voltage	40	V
V <sub>EB0</sub>	Emitter-Base Voltage	6	V
I <sub>C</sub>	Collector Current -Continuous	0.6	A
P <sub>C</sub>	Collector Power Dissipation	0.2	W
R <sub>θJA</sub>	Thermal Resistance from Junction to Ambient	625	°C/W
T <sub>J</sub> , T <sub>stg</sub>	Operation Junction and Storage Temperature Range	-55 ~ +150	°C

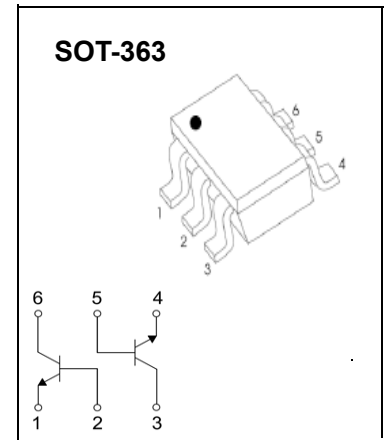

### NPN 4401 ELECTRICAL CHARACTERISTICS (Ta=25°C unless otherwise specified)

Parameter	Symbol	Test conditions	Min	Max	Unit
Collector-base breakdown voltage	V <sub>(BR)CBO</sub>	I <sub>C</sub> = 100 μA, I <sub>E</sub> = 0	60		V
Collector-emitter breakdown voltage	V <sub>(BR)CEO</sub>	I <sub>C</sub> = 1mA, I <sub>B</sub> = 0	40		V
Emitter-base breakdown voltage	V <sub>(BR)EBO</sub>	I <sub>E</sub> = 100 μA, I <sub>C</sub> = 0	6		V
Collector cut-off current	I <sub>CBO</sub>	V <sub>CB</sub> = 50 V, I <sub>E</sub> = 0		0.1	μA
Collector cut-off current	I <sub>CEO</sub>	V <sub>CE</sub> = 35 V, I <sub>B</sub> = 0		0.5	μA
Emitter cut-off current	I <sub>EBO</sub>	V <sub>EB</sub> = 5V, I <sub>C</sub> = 0		0.1	μA
DC current gain	h <sub>FE(1)</sub>	V <sub>CE</sub> = 1V, I <sub>C</sub> = 0.1mA	20		
	h <sub>FE(2)</sub>	V <sub>CE</sub> = 1V, I <sub>C</sub> = 1mA	40		
	h <sub>FE(3)</sub>	V <sub>CE</sub> = 1V, I <sub>C</sub> = 10mA	80		
	h <sub>FE(4)</sub>	V <sub>CE</sub> = 1V, I <sub>C</sub> = 150mA	100	300	
	h <sub>FE(5)</sub>	V <sub>CE</sub> = 2V, I <sub>C</sub> = 500mA	40		
Collector-emitter saturation voltage	V <sub>CE(sat)1</sub>	I <sub>C</sub> = 150 mA, I <sub>B</sub> = 15mA		0.4	V
	V <sub>CE(sat)2</sub>	I <sub>C</sub> = 500 mA, I <sub>B</sub> = 50mA		0.75	V
Base-emitter saturation voltage	V <sub>BE(sat)1</sub>	I <sub>C</sub> = 150 mA, I <sub>B</sub> = 15mA	0.75	0.95	V
	V <sub>BE(sat)2</sub>	I <sub>C</sub> = 500 mA, I <sub>B</sub> = 50mA		1.2	V
Transition frequency	f <sub>T</sub>	V <sub>CE</sub> = 10V, I <sub>C</sub> = 20mA, f = 100MHz	250		MHz
Output capacitance	C <sub>ob</sub>	V <sub>CB</sub> = 5V, I <sub>E</sub> = 0, f = 1MHz		6.5	pF
Delay time	t <sub>d</sub>	V <sub>CC</sub> = 30V,		15	nS
Rise time	t <sub>r</sub>	V <sub>BE</sub> = 2V, I <sub>C</sub> = 150mA, I <sub>B1</sub> = 15mA		20	nS
Storage time	t <sub>s</sub>	V <sub>CC</sub> = 30V, I <sub>C</sub> = 150mA, I <sub>B1</sub> = -I <sub>B2</sub> = 15mA		225	nS
Fall time	t <sub>f</sub>			30	nS

# Typical Characteristics

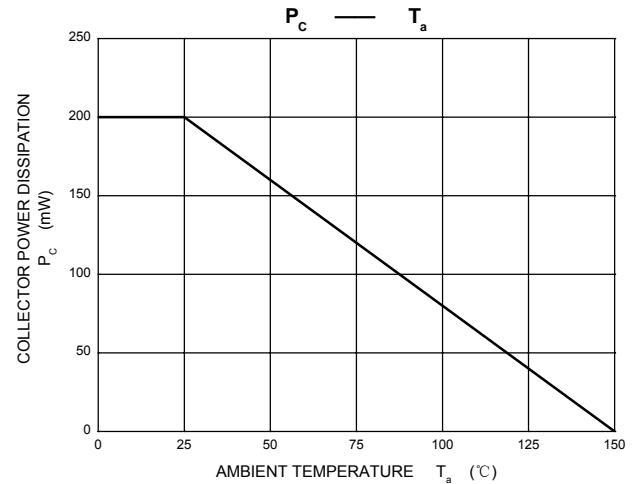
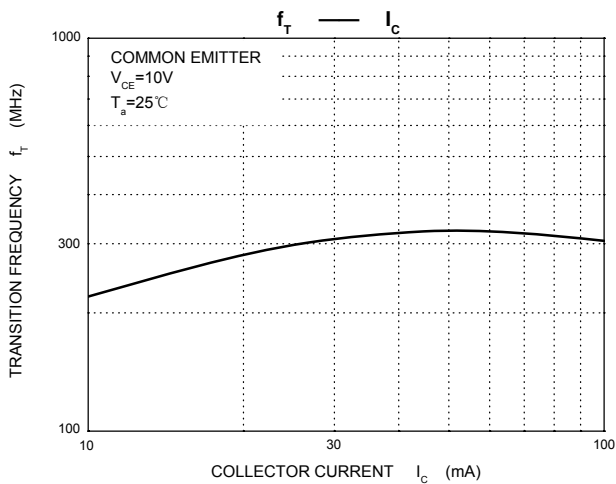
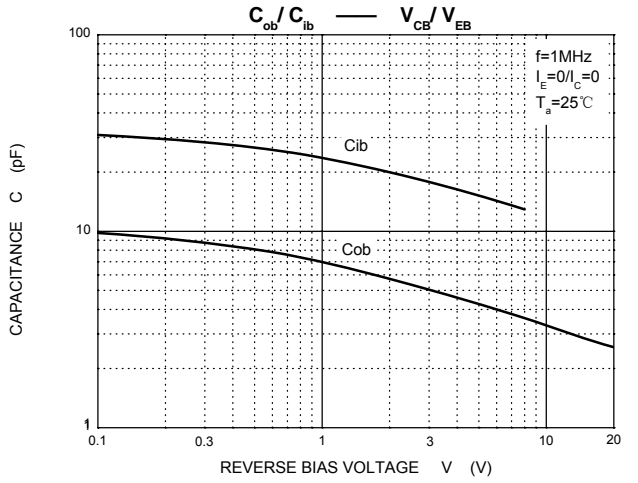
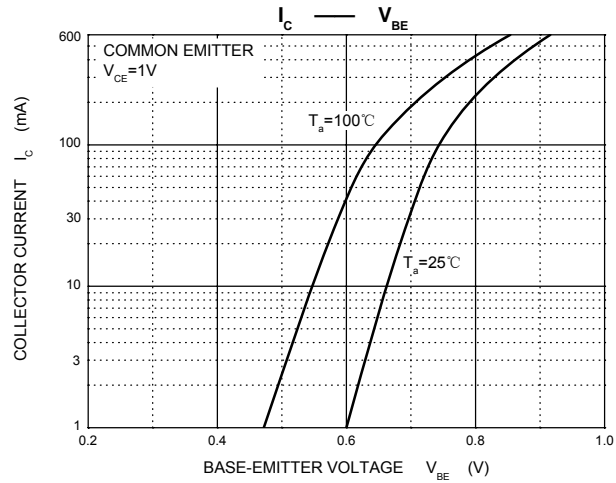
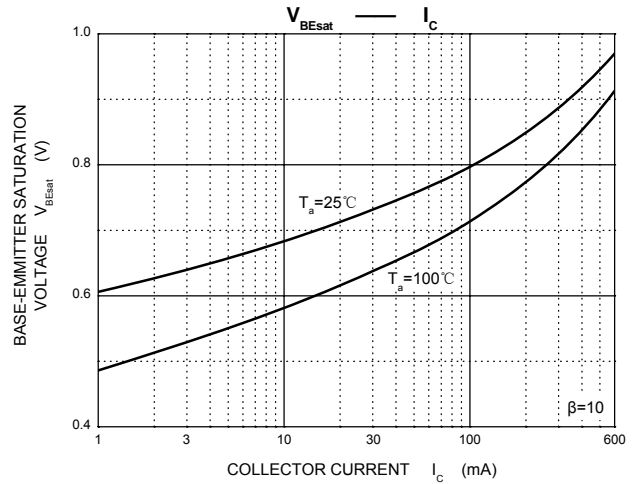
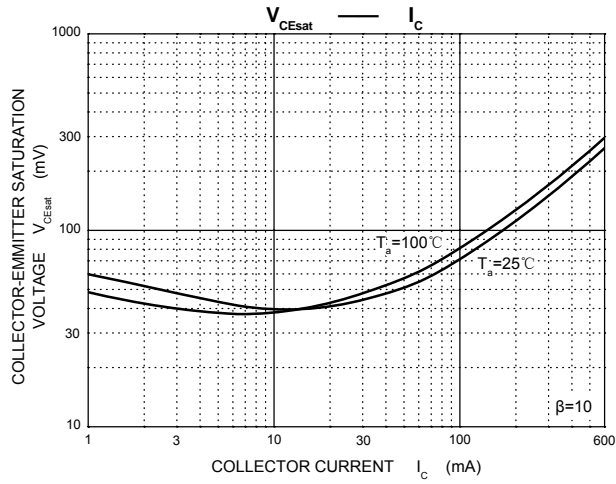
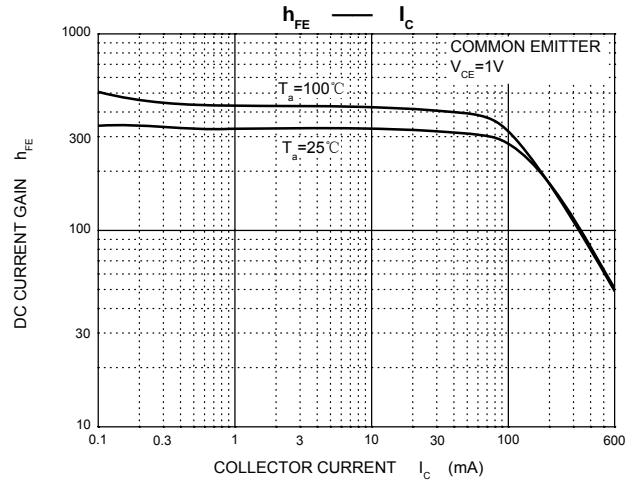
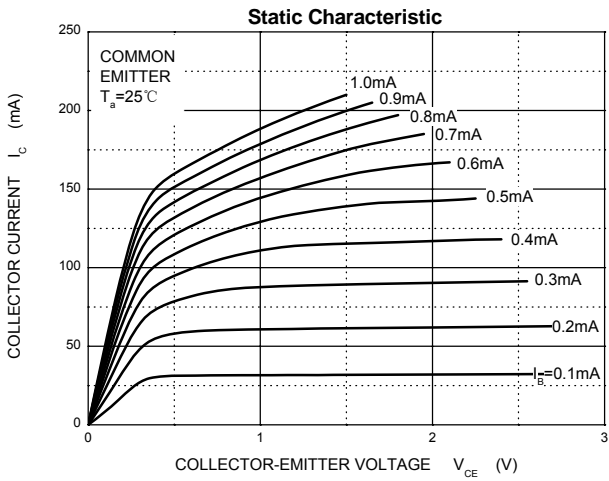

## SOT-363 Package Outline Dimensions

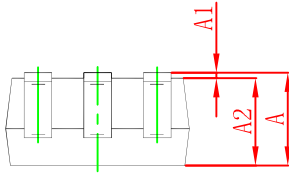
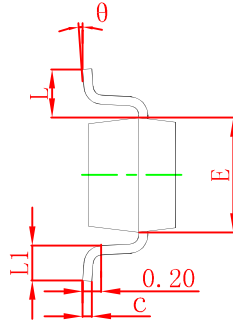
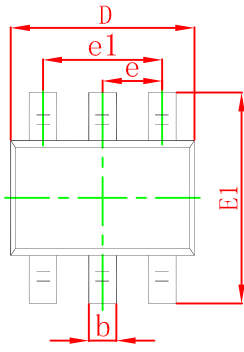

Symbol	Dimensions In Millimeters		Dimensions In Inches	
	Min	Max	Min	Max
A	0.900	1.100	0.035	0.043
A1	0.000	0.100	0.000	0.004
A2	0.900	1.000	0.035	0.039
b	0.150	0.350	0.006	0.014
c	0.100	0.150	0.004	0.006
D	2.000	2.200	0.079	0.087
E	1.150	1.350	0.045	0.053
E1	2.150	2.400	0.085	0.094
e	0.650 TYP		0.026 TYP	
e1	1.200	1.400	0.047	0.055
L	0.525 REF		0.021 REF	
L1	0.260	0.460	0.010	0.018
theta	0°	8°	0°	8°

## SOT-363 Suggested Pad Layout

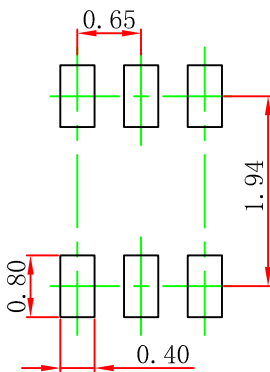

### Note:

1. Controlling dimension: in millimeters.
2. General tolerance:  $\pm 0.05\text{mm}$ .
3. The pad layout is for reference purposes only.

# SOT-363 Tape and Reel

## SOT-363 Embossed Carrier Tape

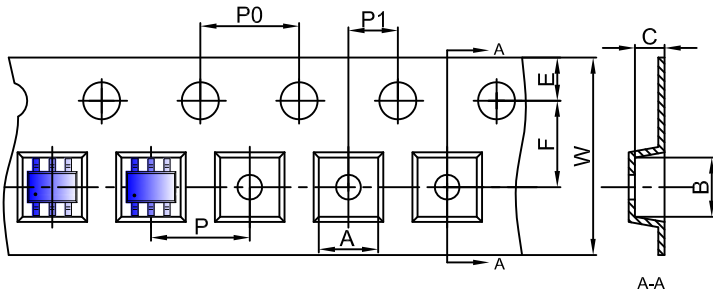

### Packaging Description:

SOT-363 parts are shipped in tape. The carrier tape is made from a dissipative (carbon filled) polycarbonate resin. The cover tape is a multilayer film (Heat Activated Adhesive in nature) primarily composed of polyester film, adhesive layer, sealant, and anti-static sprayed agent. These reeled parts in standard option are shipped with 3,000 units per 7" or 17.8cm diameter reel. The reels are clear in color and is made of polystyrene plastic (anti-static coated).

Dimensions are in millimeter										
Pkg type	A	B	C	d	E	F	P0	P	P1	W
SOT-363	2.25	2.55	1.20	Ø1.50	1.75	3.50	4.00	4.00	2.00	8.00

## SOT-363 Tape Leader and Trailer

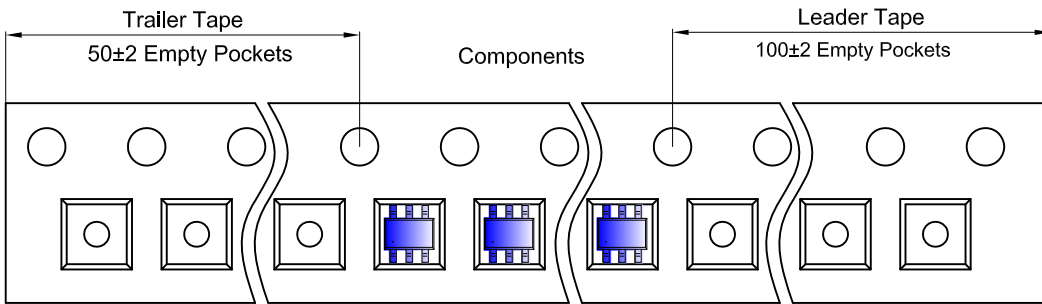

## SOT-363 Reel

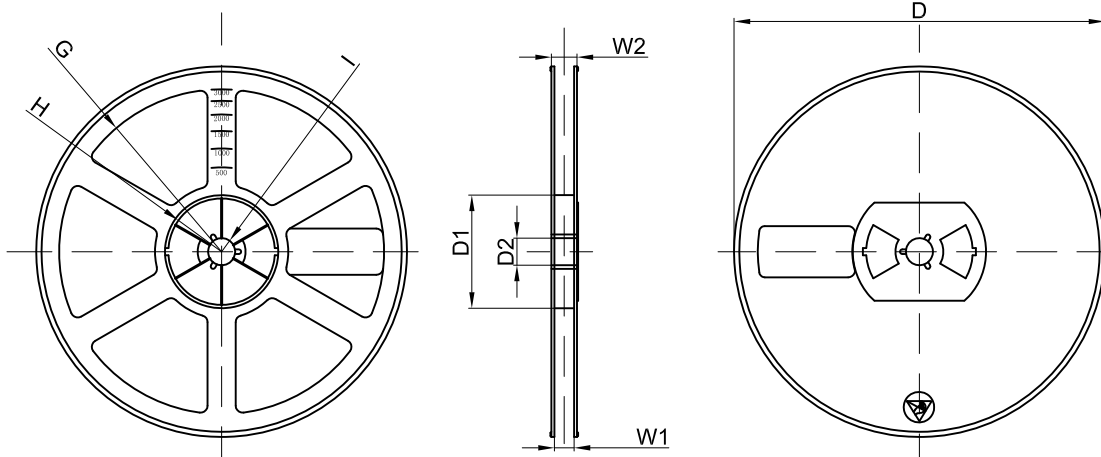

Dimensions are in millimeter								
Reel Option	D	D1	D2	G	H	I	W1	W2
7" Dia	Ø178.00	54.40	13.00	R78.00	R25.60	R6.50	9.50	12.30

REEL	Reel Size	Box	Box Size(mm)	Carton	Carton Size(mm)	G.W.(kg)
3000 pcs	7 inch	45,000 pcs	203×203×195	180,000 pcs	438×438×220	