



SOT-363 Plastic-Encapsulate Transistors

MMDT3904 DUAL TRANSISTOR (NPN+NPN)

FEATURES

- Epitaxial planar die construction
- Ideal for low power amplification and switching

MARKING:K6N

MAXIMUM RATINGS ($T_a=25^\circ\text{C}$ unless otherwise noted)

Symbol	Parameter	Value	Units
V_{CB0}	Collector-Base Voltage	60	V
V_{CEO}	Collector-Emitter Voltage	40	V
V_{EBO}	Emitter-Base Voltage	6	V
I_C	Collector Current -Continuous	0.2	A
P_C	Collector Power Dissipation	0.2	W
T_J, T_{stg}	Operation Junction and Storage Temperature Range	-55~+150	$^\circ\text{C}$

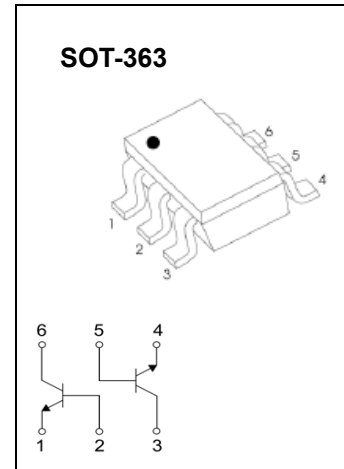

ELECTRICAL CHARACTERISTICS ($T_a=25^\circ\text{C}$ unless otherwise specified)

Parameter	Symbol	Test conditions	Min	Typ	Max	Unit
Collector-base breakdown voltage	$V_{(BR)CBO}$	$I_C=10\mu\text{A}, I_E=0$	60			V
Collector-emitter breakdown voltage	$V_{(BR)CEO}$	$I_C=1\text{mA}, I_B=0$	40			V
Emitter-base breakdown voltage	$V_{(BR)EBO}$	$I_E=10\mu\text{A}, I_C=0$	6			V
Collector cut-off current	I_{CBO}	$V_{CB}=30\text{V}, I_E=0$			0.05	μA
Emitter cut-off current	I_{EBO}	$V_{EB}=5\text{V}, I_C=0$			0.05	μA
Collector cut-off current	I_{CEX}	$V_{CE}=30\text{V}, V_{BE(off)}=3\text{V}$			0.05	μA
DC current gain	$h_{FE(1)}$	$V_{CE}=1\text{V}, I_C=0.1\text{mA}$	40			
	$h_{FE(2)}$	$V_{CE}=1\text{V}, I_C=1\text{mA}$	70			
	$h_{FE(3)}$	$V_{CE}=1\text{V}, I_C=10\text{mA}$	100		300	
	$h_{FE(4)}$	$V_{CE}=1\text{V}, I_C=50\text{mA}$	60			
	$h_{FE(5)}$	$V_{CE}=1\text{V}, I_C=100\text{mA}$	30			
Collector-emitter saturation voltage	$V_{CE(sat)1}$	$I_C=10\text{mA}, I_B=1\text{mA}$			0.2	V
	$V_{CE(sat)2}$	$I_C=50\text{mA}, I_B=5\text{mA}$			0.3	V
Base-emitter saturation voltage	$V_{BE(sat)1}$	$I_C=10\text{mA}, I_B=1\text{mA}$	0.65		0.85	V
	$V_{BE(sat)2}$	$I_C=50\text{mA}, I_B=5\text{mA}$			0.95	V
Transition frequency	f_T	$V_{CE}=20\text{V}, I_C=10\text{mA}, f=100\text{MHz}$	300			MHz
Collector output capacitance	C_{ob}	$V_{CB}=5\text{V}, I_E=0, f=1\text{MHz}$			4	pF
Noise figure	NF	$V_{CE}=5\text{V}, I_C=0.1\text{mA}, f=1\text{kHz}, R_S=1\text{K}\Omega$			5	dB
Delay time	t_d	$V_{CC}=3\text{V}, V_{BE(off)}=-0.5\text{V}$			35	nS
Rise time	t_r	$I_C=10\text{mA}, I_{B1}=-I_{B2}=1\text{mA}$			35	nS
Storage time	t_s	$V_{CC}=3\text{V}, I_C=10\text{mA}$			200	nS
Fall time	t_f	$I_{B1}=-I_{B2}=1\text{mA}$			50	nS

Typical Characteristics

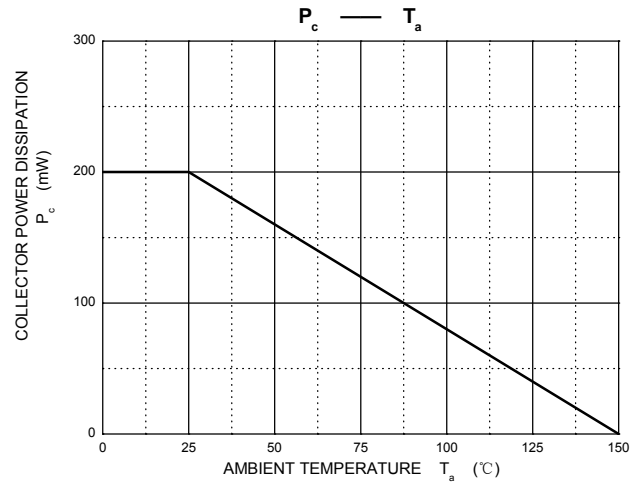
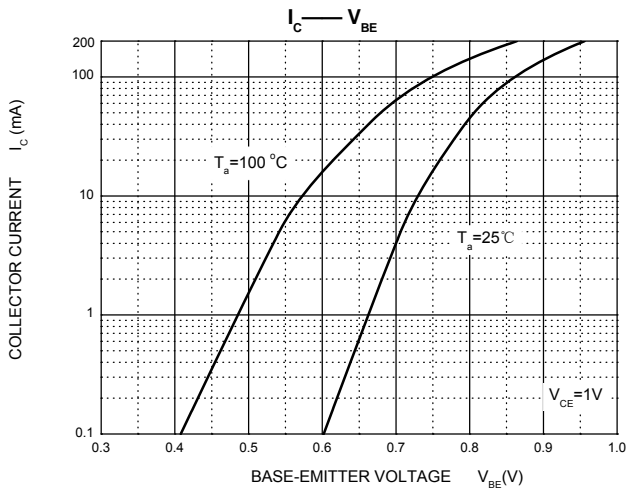
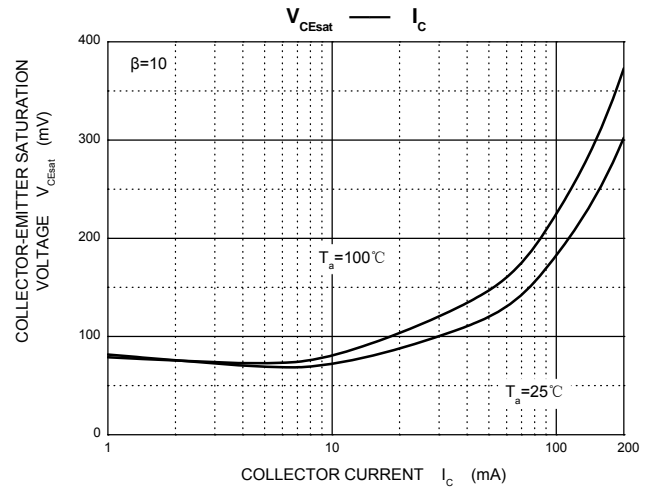
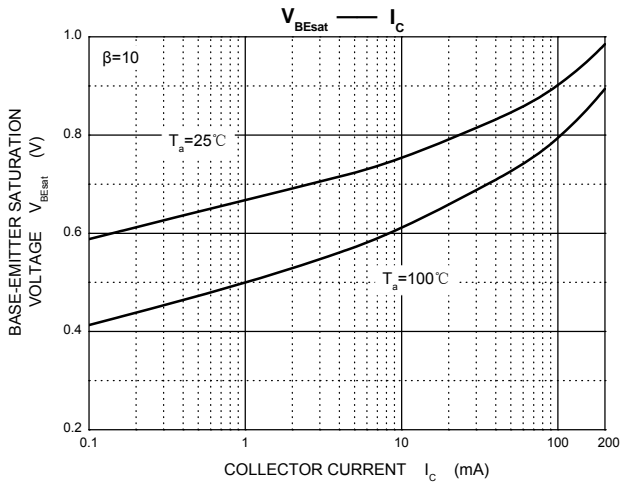
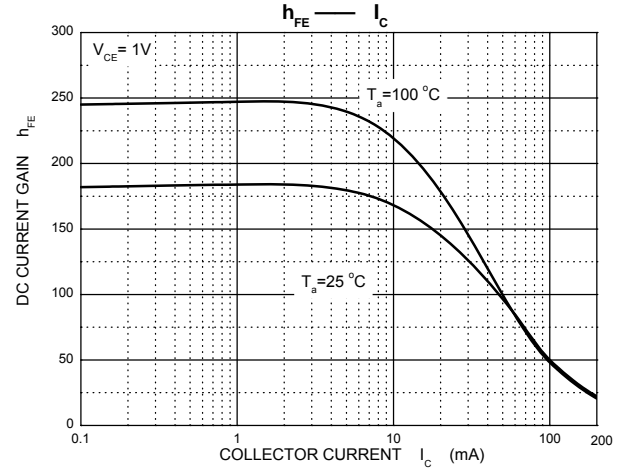
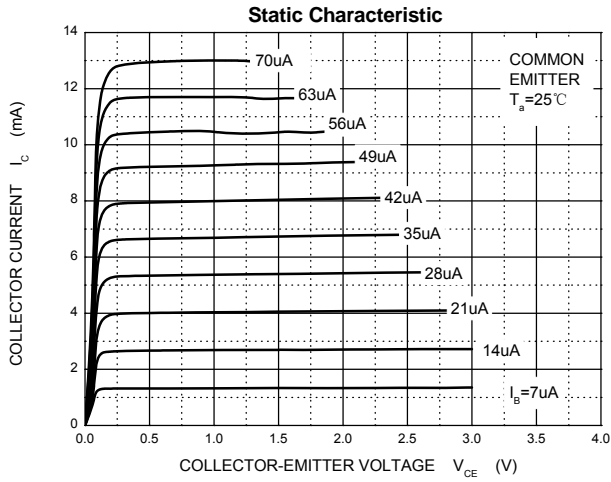

SOT-363 Package Outline Dimensions

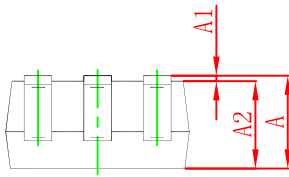
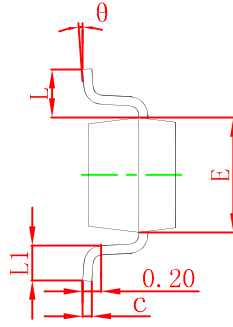
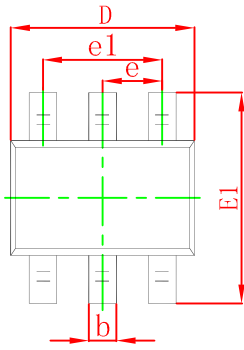

Symbol	Dimensions In Millimeters		Dimensions In Inches	
	Min	Max	Min	Max
A	0.900	1.100	0.035	0.043
A1	0.000	0.100	0.000	0.004
A2	0.900	1.000	0.035	0.039
b	0.150	0.350	0.006	0.014
c	0.100	0.150	0.004	0.006
D	2.000	2.200	0.079	0.087
E	1.150	1.350	0.045	0.053
E1	2.150	2.400	0.085	0.094
e	0.650 TYP		0.026 TYP	
e1	1.200	1.400	0.047	0.055
L	0.525 REF		0.021 REF	
L1	0.260	0.460	0.010	0.018
θ	0°	8°	0°	8°

SOT-363 Suggested Pad Layout

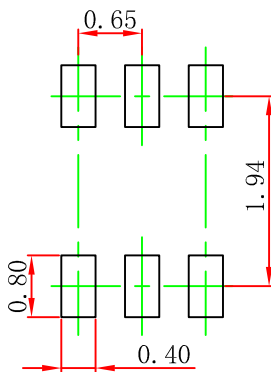

Note:

1. Controlling dimension: in millimeters.
2. General tolerance: $\pm 0.05\text{mm}$.
3. The pad layout is for reference purposes only.

SOT-363 Tape and Reel

SOT-363 Embossed Carrier Tape

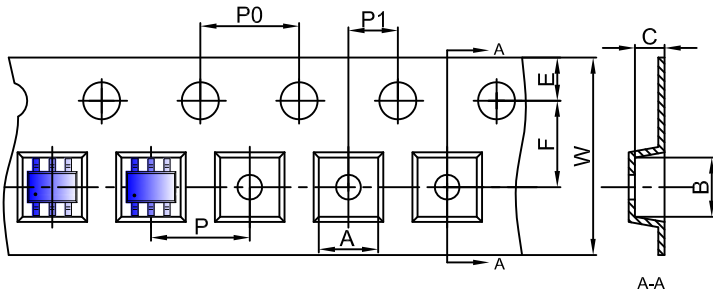

Packaging Description:

SOT-363 parts are shipped in tape. The carrier tape is made from a dissipative (carbon filled) polycarbonate resin. The cover tape is a multilayer film (Heat Activated Adhesive in nature) primarily composed of polyester film, adhesive layer, sealant, and anti-static sprayed agent. These reeled parts in standard option are shipped with 3,000 units per 7" or 17.8cm diameter reel. The reels are clear in color and is made of polystyrene plastic (anti-static coated).

Dimensions are in millimeter										
Pkg type	A	B	C	d	E	F	P0	P	P1	W
SOT-363	2.25	2.55	1.20	Ø1.50	1.75	3.50	4.00	4.00	2.00	8.00

SOT-363 Tape Leader and Trailer

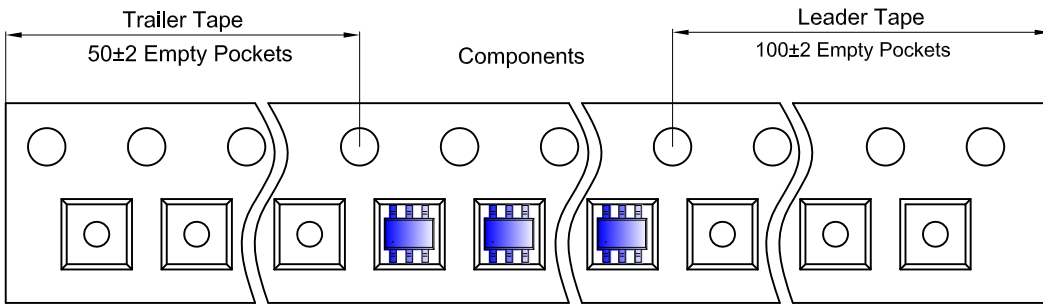

SOT-363 Reel

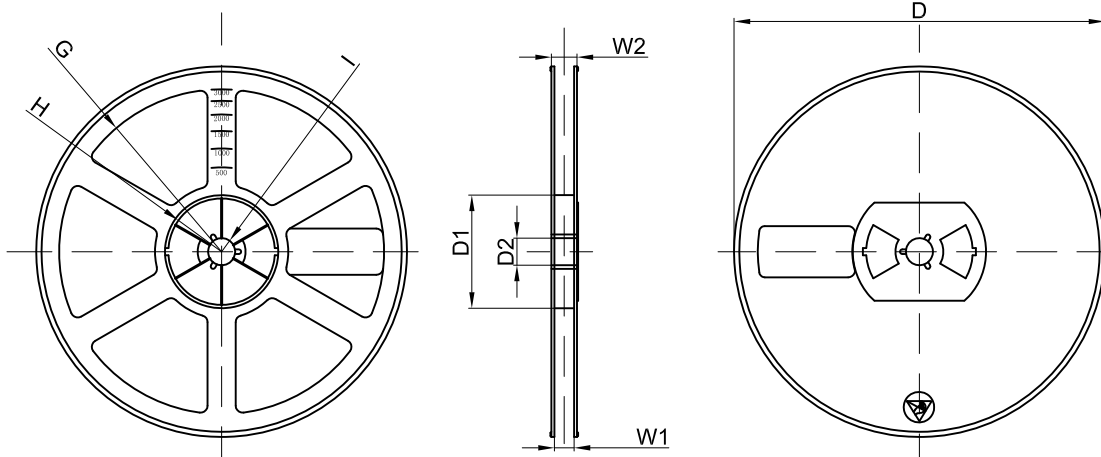

Dimensions are in millimeter								
Reel Option	D	D1	D2	G	H	I	W1	W2
7"Dia	Ø178.00	54.40	13.00	R78.00	R25.60	R6.50	9.50	12.30

REEL	Reel Size	Box	Box Size(mm)	Carton	Carton Size(mm)	G.W.(kg)
3000 pcs	7 inch	45,000 pcs	203×203×195	180,000 pcs	438×438×220	