

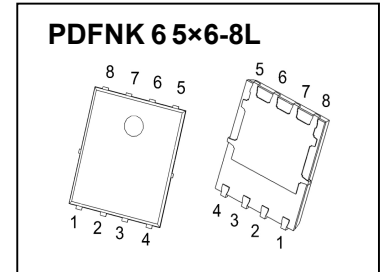

PDFNK 6 5×6-8L Plastic-Encapsulate MOSFETS

AC110SN10 N-Channel Power MOSFET

| | | |
|---------------|-----------------|-------|
| $V_{(BR)DSS}$ | $R_{DS(on)TYP}$ | I_D |
| 100V | 4.3mΩ@10V | 110A |



DESCRIPTION

The CJAC110SN10 uses shielded gate trench technology and design to provide excellent $R_{DS(ON)}$ with low gate charge. It can be used in a wide variety of applications

FEATURES

- High Power and current handing capability
- Load switch
- High density cell design for ultra low $R_{DS(ON)}$
- Lead free product is acquired
- Good stability and uniformity with high E_{AS}
- Excellent package for good heat dissipation

APPLICATIONS

- SMPS and general purpose applications
- Hard switched and high frequency circuits
- Uninterruptible Power Supply
- Power management

MARKING

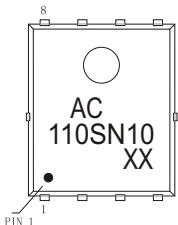

AC110SN10 = Part No.
 Solid dot = Pin1 indicator
 XX = Code

EQUIVALENT CIRCUIT

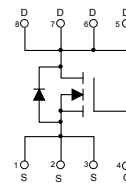

MAXIMUM RATINGS ($T_a=25^\circ\text{C}$ unless otherwise noted)

| Parameter | Symbol | Limit | Unit |
|--|-------------------|----------|------|
| Drain-Source Voltage | V_{DS} | 100 | V |
| Gate-Source Voltage | V_{GS} | ±20 | V |
| Continuous Drain Current | I_D ① | 110 | A |
| Pulsed Drain Current | I_{DM} ② | 390 | A |
| Single Pulsed Avalanche Energy | E_{AS} ③ | 65 | mJ |
| Power Dissipation | P_D ① | 61.6 | W |
| Thermal Resistance from Junction to Ambient | $R_{\theta JA}$ ⑥ | 62.5 | °C/W |
| Thermal Resistance from Junction to Case | $R_{\theta JC}$ ① | 2.03 | °C/W |
| Operating Junction and Storage Temperature Range | T_J, T_{stg} | -55~+150 | °C |

MOSFET ELECTRICAL CHARACTERISTICS

$T_a=25\text{ }^\circ\text{C}$ unless otherwise specified

| Parameter | Symbol | Test Condition | Min | Typ | Max | Unit |
|---|-----------------------|--|-----------------------------------|------|-----------|------------|
| Off characteristics | | | | | | |
| Drain-source breakdown voltage | $V_{(BR)DSS}$ | $V_{GS} = 0V, I_D = 250\mu A$ | 100 | | | V |
| Zero gate voltage drain current | I_{DSS} | $V_{DS} = 80V, V_{GS} = 0V$ | $T_J = 25\text{ }^\circ\text{C}$ | | 1 | μA |
| | | | $T_J = 125\text{ }^\circ\text{C}$ | | 100 | |
| Gate-body leakage current | I_{GSS} | $V_{DS} = 0V, V_{GS} = \pm 20V$ | | | ± 100 | nA |
| On characteristics ^④ | | | | | | |
| Gate-threshold voltage | $V_{GS(th)}$ | $V_{DS} = V_{GS}, I_D = 250\mu A$ | 2.0 | 3.0 | 4.0 | V |
| Static drain-source on-state resistance | $R_{DS(on)}$ | $V_{GS} = 10V, I_D = 20A$ | | 4.3 | 5.0 | m Ω |
| Dynamic characteristics ^{④ ⑤} | | | | | | |
| Input capacitance | C_{iss} | $V_{DS} = 45V, V_{GS} = 0V, f = 100\text{KHz}$ | | 3907 | 7814 | μF |
| Output capacitance | C_{oss} | | | 794 | 1588 | |
| Reverse transfer capacitance | C_{rss} | | | 16 | 32 | |
| Gate resistance | R_g | $f = 1\text{MHz}$ | | 1.9 | | Ω |
| Switching characteristics ^{④ ⑤} | | | | | | |
| Total gate charge | Q_g | $V_{GS} = 10V, V_{DS} = 50V, I_D = 22A$ | | 66.5 | 133 | nC |
| Gate-source charge | Q_{gs} | | | 15.9 | 31.8 | |
| Gate-drain charge | Q_{gd} | | | 19.8 | 39.6 | |
| Turn-on delay time | $t_{d(on)}$ | $V_{DS} = 50V, I_D = 22A, V_{GS} = 10V, R_g = 2.2\Omega$ | | 28.2 | | ns |
| Turn-on rise time | t_r | | | 7.5 | | |
| Turn-off delay time | $t_{d(off)}$ | | | 81.9 | | |
| Turn-off fall time | t_f | | | 20.1 | | |
| Drain-Source Diode Characteristics | | | | | | |
| Drain-source diode forward voltage | V_{SD} ^④ | $V_{GS} = 0V, I_S = 25A$ | | | 1.0 | V |
| Continuous drain-source diode forward current | I_S ^① | | | | 110 | A |
| Pulsed drain-source diode forward current | I_{SM} ^② | | | | 390 | A |

Notes:

- $T_C = 25\text{ }^\circ\text{C}$ Limited only by maximum temperature allowed.
- $P_w \leq 10\mu s$, Duty cycle $\leq 1\%$.
- EAS condition: $V_{DD} = 50V, V_{GS} = 10V, L = 0.1\text{mH}, R_g = 25\Omega$ Starting $T_J = 25\text{ }^\circ\text{C}$.
- Pulse Test : Pulse Width $\leq 300\mu s$, duty cycle $\leq 2\%$.
- Guaranteed by design, not subject to production.
- The value of $R_{\theta JA}$ is measured with the device mounted on 1 in 2 FR-4 board with 2oz. Copper, in a still air environment with $T_a = 25\text{ }^\circ\text{C}$.

Typical Characteristics

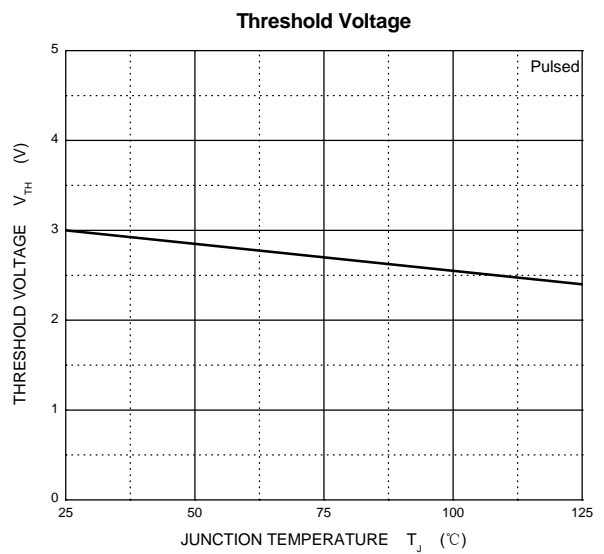
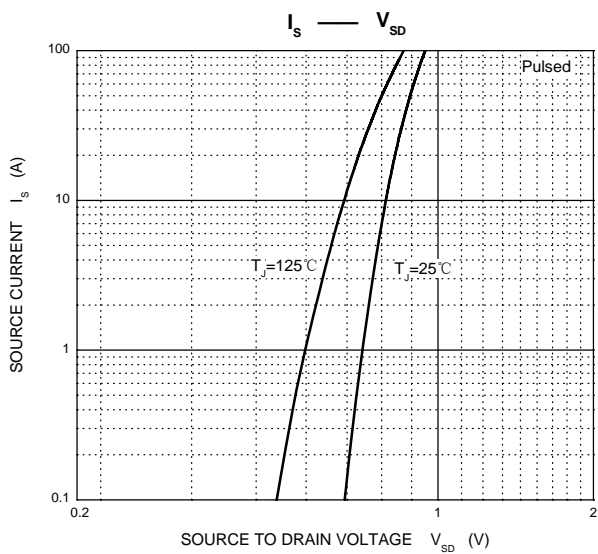
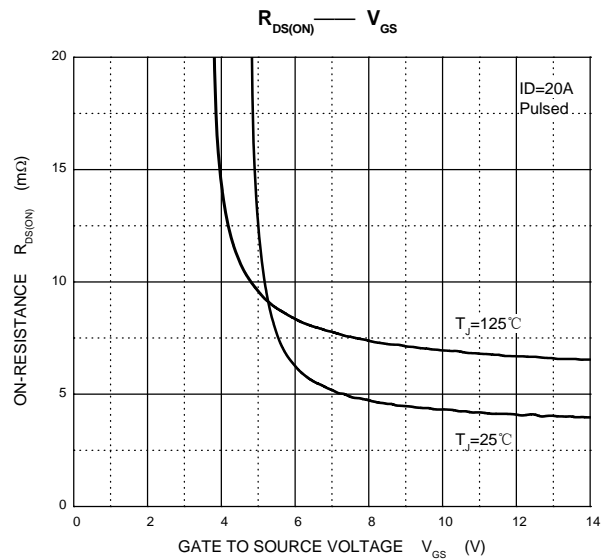
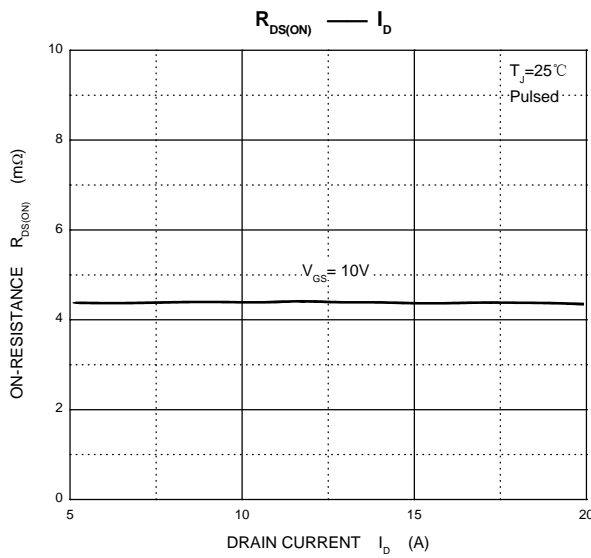
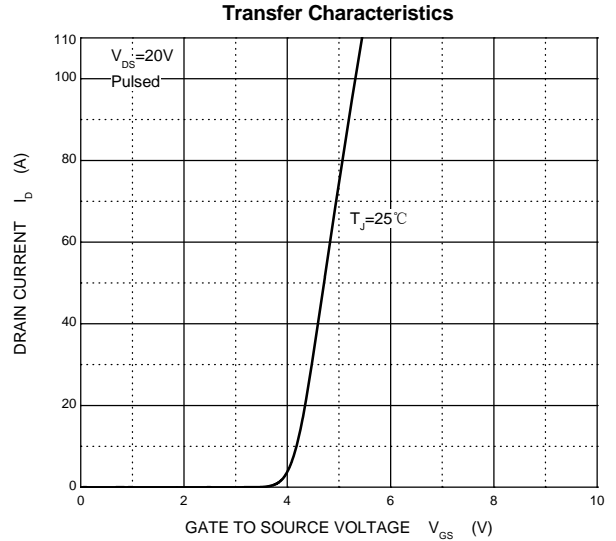
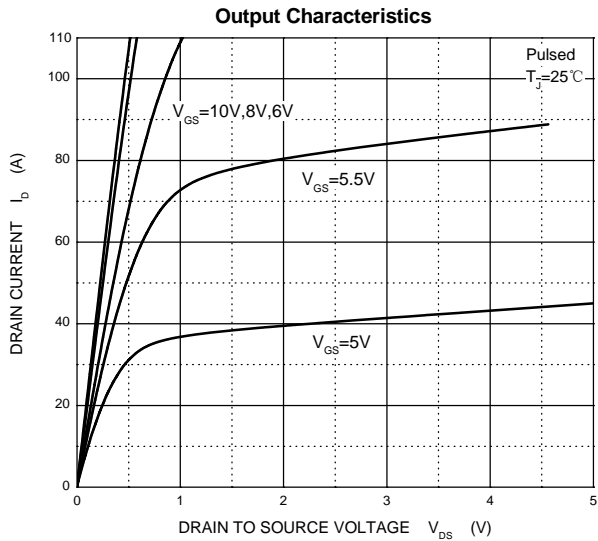

Typical Characteristics

Capacitances

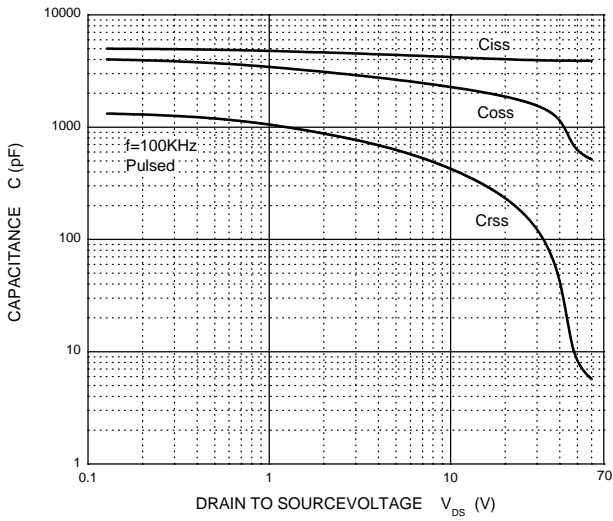

Gate Charge

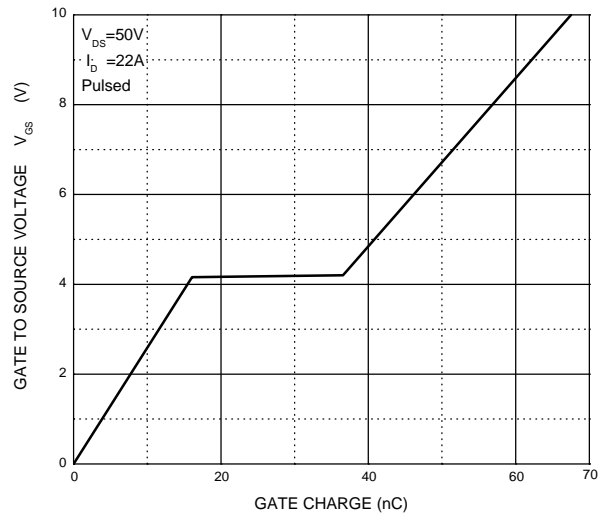

Normalized Maximum Transient Thermal Impedance

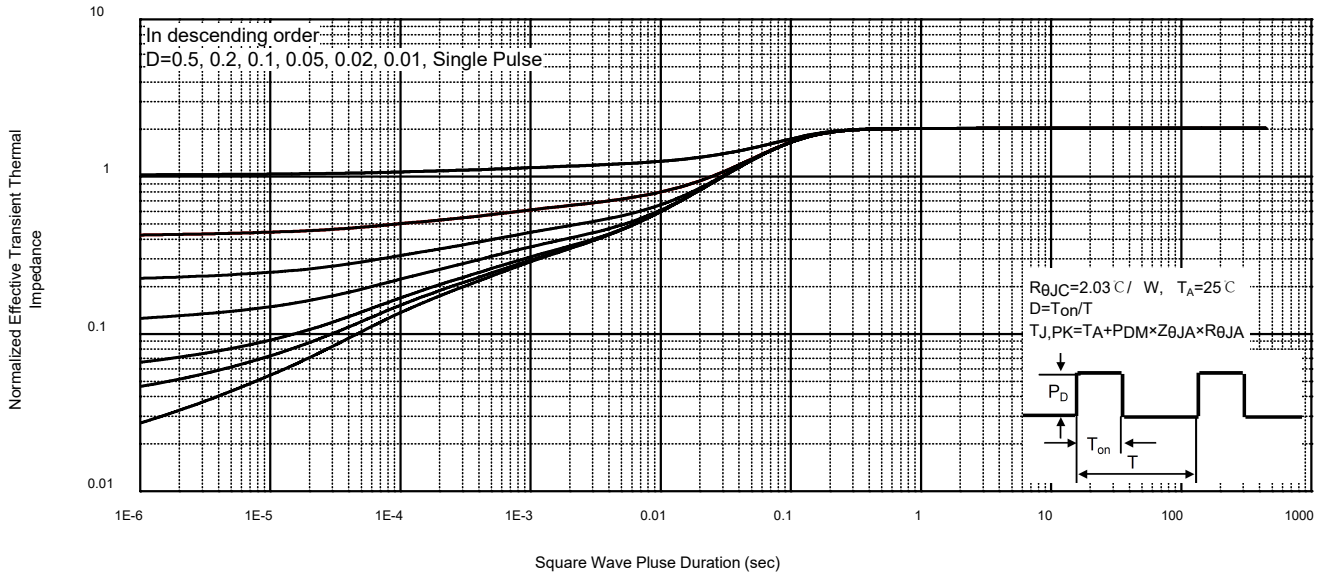

Maximum Forward Biased Safe Operating Area

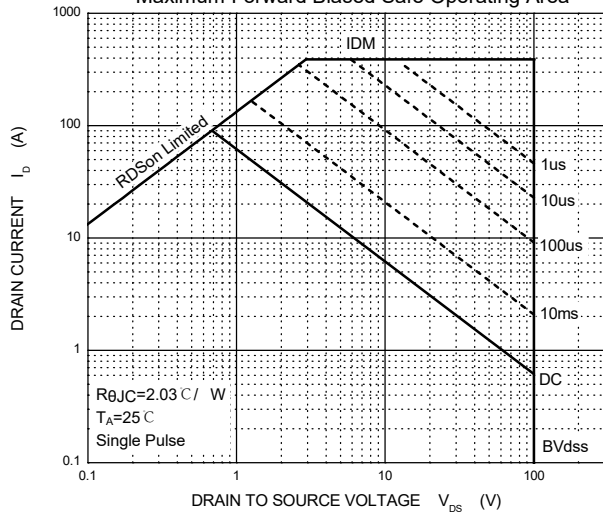

PDFNWB5x6-8L Package Outline Dimensions

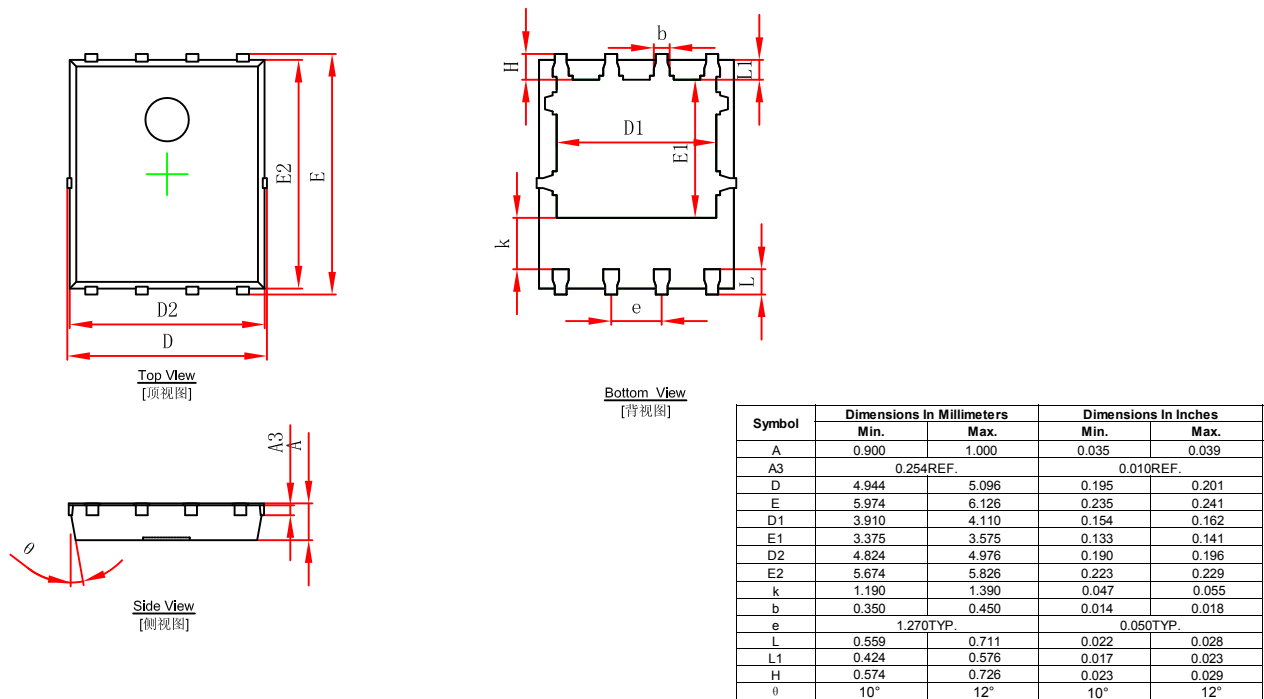

PDFNWB5x6-8L Suggested Pad Layout

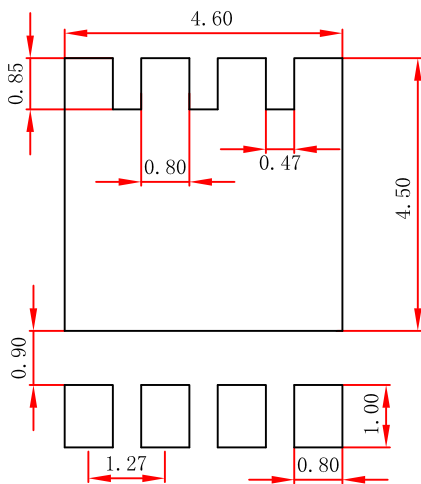

Note:

1. Controlling dimension: in millimeters.
2. General tolerance: $\pm 0.05\text{mm}$.
3. The pad layout is for reference purposes only.

PDFNWB5×6 Tape and Reel

PDFNWB5×6-8L Embossed Carrier Tape

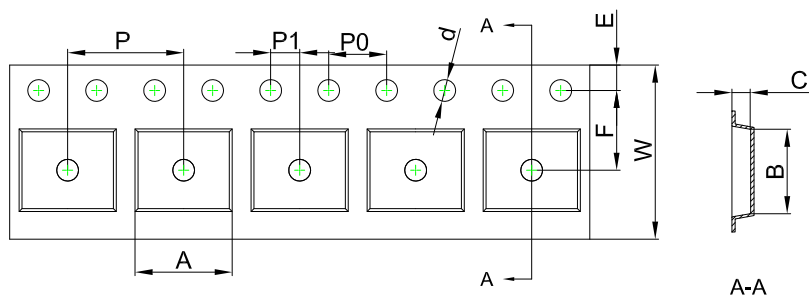

Packaging Description:
PDFNWB5×6-8L parts are shipped in tape. The carrier tape is made from a dissipative (carbon filled) polycarbonate resin. The cover tape is a multilayer film (Heat Activated Adhesive in nature) primarily composed of polyester film, adhesive layer, sealant, and anti-static sprayed agent. These reeled parts in standard option are shipped with 5,000 units per 13" or 33.0 cm diameter reel. The reels are clear in color and is made of polystyrene plastic (anti-static coated).

| Dimensions are in millimeter | | | | | | | | | | |
|------------------------------|------|------|------|-------|------|------|------|------|------|-------|
| Pkg type | A | B | C | d | E | F | P0 | P | P1 | W |
| PDFNWB5×6-8L | 6.30 | 5.30 | 1.10 | Ø1.50 | 1.75 | 5.50 | 4.00 | 8.00 | 2.00 | 12.00 |

PDFNWB5×6-8L Tape Leader and Trailer

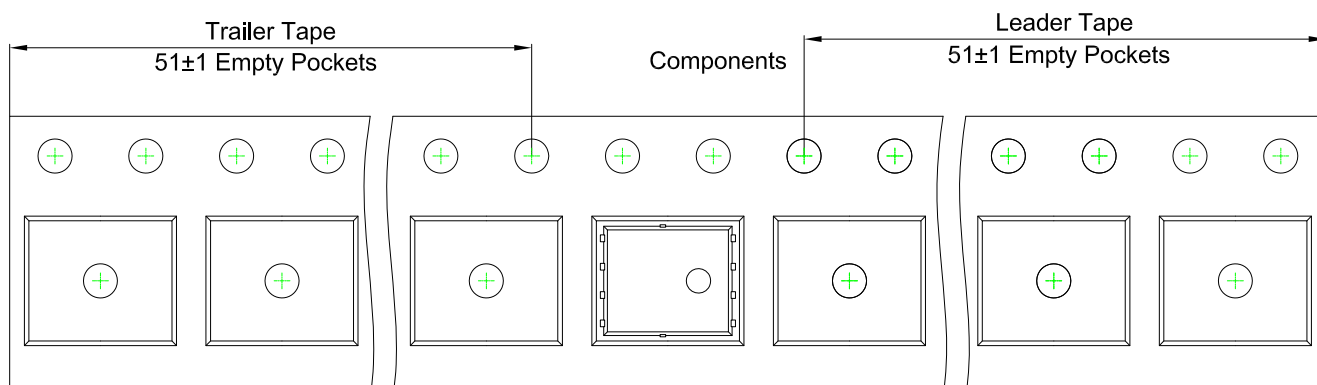

PDFNWB5×6-8L Reel

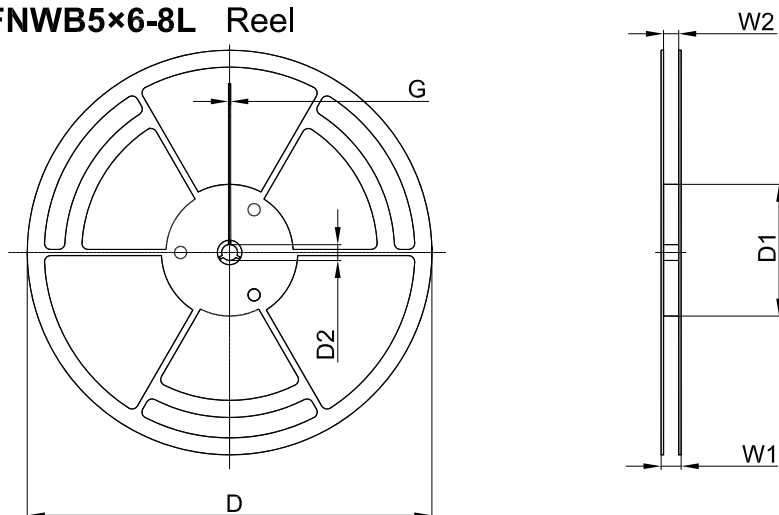

| Dimensions are in millimeter | | | | | | |
|------------------------------|---------|--------|-------|------|-------|-------|
| Reel Option | D | D1 | D2 | G | W1 | W2 |
| 13"Dia | Ø330.00 | 100.00 | 13.00 | 1.90 | 17.60 | 12.40 |

| REEL | Reel Size | Box | Box Size(mm) | Carton | Carton Size(mm) |
|-----------|-----------|-----------|--------------|------------|-----------------|
| 5,000 pcs | 13 inch | 5,000 pcs | 340×336×29 | 50,000 pcs | 353×346×365 |