

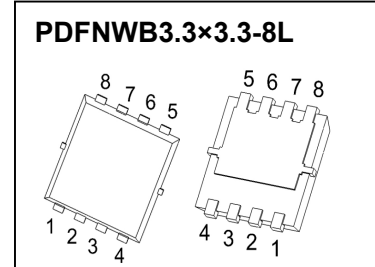

PDFNWB3.3×3.3-8L Plastic-Encapsulate MOSFETS

AB18SN03 N-Channel Power MOSFET

$V_{(BR)DSS}$	$R_{DS(on)TYP}$	I_D
30V	10.5mΩ@10V	18A
	16.5mΩ@4.5V	



DESCRIPTION

The AB18SN03 uses shielded gate trench technology and design to provide excellent $R_{DS(ON)}$ with low gate charge. It can be used in a wide variety of applications

FEATURES

- High density cell design for ultra low $R_{DS(ON)}$
- Fully characterized avalanche voltage and current
- Good stability and uniformity with high E_{AS}
- Excellent package for good heat dissipation
- Special process technology for high ESD capability

APPLICATIONS

- High side switch in POL DC/DC converter
- Secondary side synchronous rectifier

MARKING

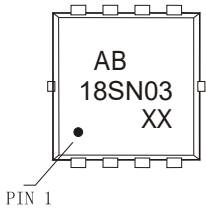

AB18SN03 = Part No.
 Solid dot = Pin1 indicator.
 XX = Code.

EQUIVALENT CIRCUIT

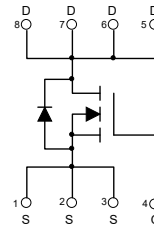

ABSOLUTE MAXIMUM RATINGS ($T_a=25^{\circ}C$ unless otherwise noted)

Parameter	Symbol	Limit	Unit
Drain-Source Voltage	V_{DS}	30	V
Gate-Source Voltage	V_{GS}	±20	V
Continuous Drain Current	I_D ①	18	A
Pulsed Drain Current	I_{DM} ②	72	A
Single Pulsed Avalanche Energy	E_{AS} ③	20	mJ
Power Dissipation	P_D ①	22	W
Thermal Resistance from Junction to Ambient	$R_{\theta JA}$ ⑥	83.3	$^{\circ}C/W$
Thermal Resistance from Junction to Case	$R_{\theta JC}$ ①	5.68	$^{\circ}C/W$
Operating Junction and Storage Temperature Range	T_J, T_{stg}	-55~+150	$^{\circ}C$

MOSFET ELECTRICAL CHARACTERISTICS

$T_a=25\text{ }^\circ\text{C}$ unless otherwise specified

Parameter	Symbol	Test Condition	Min	Typ	Max	Unit
Off characteristics						
Drain-source breakdown voltage	$V_{(BR)DSS}$	$V_{GS} = 0V, I_D = 250\mu A$	30			V
Zero gate voltage drain current	I_{DSS}	$V_{DS} = 24V, V_{GS} = 0V$	$T_J = 25\text{ }^\circ\text{C}$		1.0	μA
			$T_J = 125\text{ }^\circ\text{C}$		100	
Gate-body leakage current	I_{GSS}	$V_{DS} = 0V, V_{GS} = \pm 20V$			± 100	nA
On characteristics ^④						
Gate-threshold voltage	$V_{GS(th)}$	$V_{DS} = V_{GS}, I_D = 250\mu A$	1.0	1.7	2.5	V
Static drain-source on-state resistance	$R_{DS(on)}$	$V_{GS} = 10V, I_D = 10A$		10.5	13	m Ω
		$V_{GS} = 4.5V, I_D = 10A$		12.5	22	m Ω
Dynamic characteristics ^{④ ⑤}						
Input capacitance	C_{iss}	$V_{DS} = 15V, V_{GS} = 0V, f = 100KHz$		330	660	pF
Output capacitance	C_{oss}			150	300	
Reverse transfer capacitance	C_{rss}			6	12	
Gate resistance	R_g	$f = 1MHz$		10		Ω
Switching characteristics ^{④ ⑤}						
Total gate charge	Q_g	$V_{GS} = 10V, V_{DS} = 20V, I_D = 10A$		6.0	12	nC
Gate-source charge	Q_{gs}			0.6	1.2	
Gate-drain charge	Q_{gd}			1.5	3.0	
Turn-on delay time	$t_{d(on)}$	$V_{DD} = 5V, I_D = 10A, V_{GS} = 4.5V, R_G = 3.3\Omega$		17.5		ns
Turn-on rise time	t_r			21.3		
Turn-off delay time	$t_{d(off)}$			48		
Turn-off fall time	t_f			61		
Drain-Source Diode Characteristics						
Drain-source diode forward voltage	V_{SD} ^④	$V_{GS} = 0V, I_S = 10A$			1.2	V
Continuous drain-source diode forward current	I_S ^①				18	A
Pulsed drain-source diode forward current	I_{SM} ^②				72	A

Notes:

- $T_C = 25\text{ }^\circ\text{C}$ Limited only by maximum temperature allowed.
- $P_W \leq 10\mu s$, Duty cycle $\leq 1\%$.
- EAS condition: $V_{DD} = 15V, V_{GS} = 10V, L = 0.1mH, R_g = 25\Omega$ Starting $T_J = 25\text{ }^\circ\text{C}$.
- Pulse Test : Pulse Width $\leq 300\mu s$, duty cycle $\leq 2\%$.
- Guaranteed by design, not subject to production.
- The value of $R_{\theta JA}$ is measured with the device mounted on 1 in 2 FR-4 board with 2oz. Copper, in a still air environment with $T_a = 25\text{ }^\circ\text{C}$.

Typical Characteristics

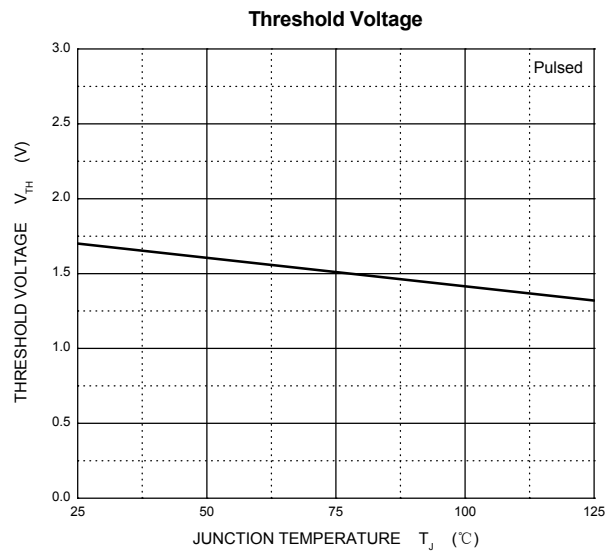
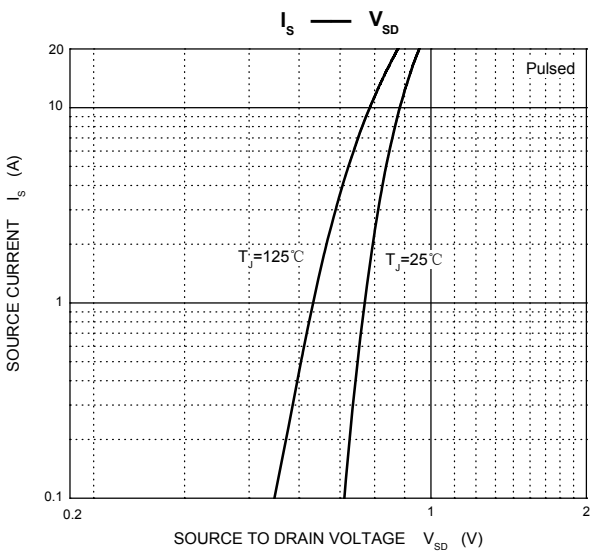
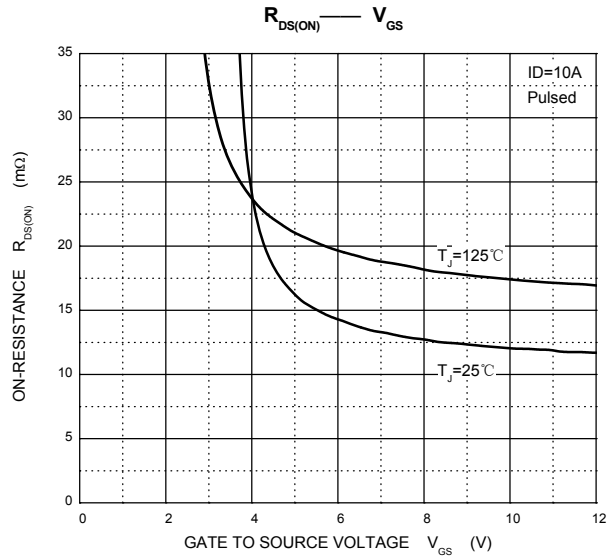
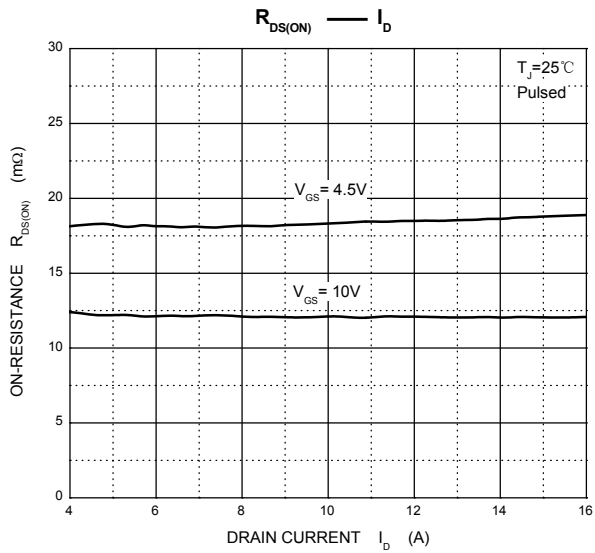
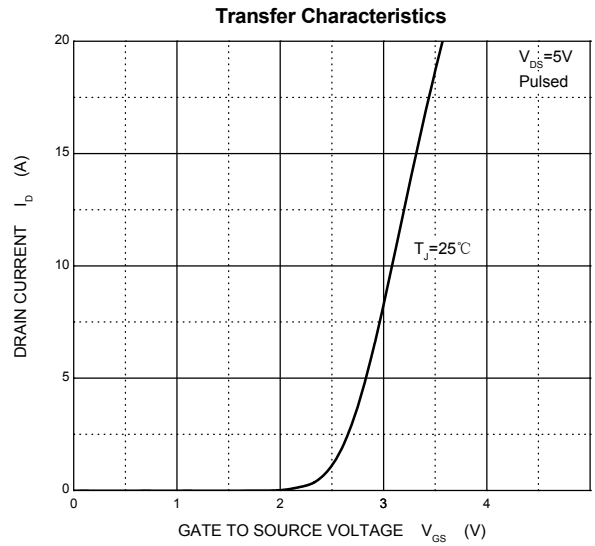
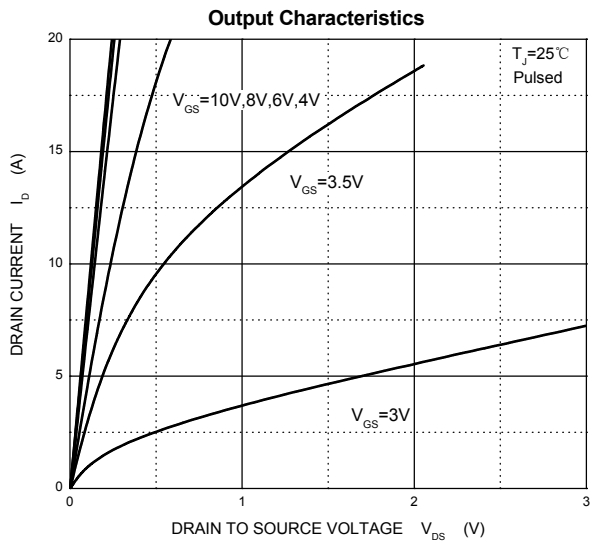

Typical Characteristics

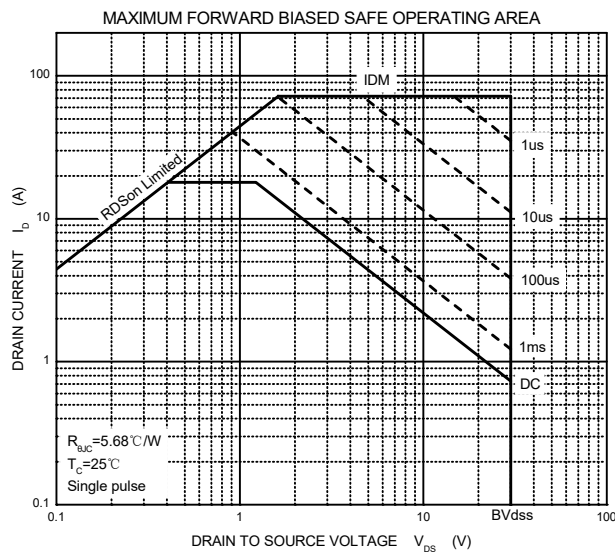
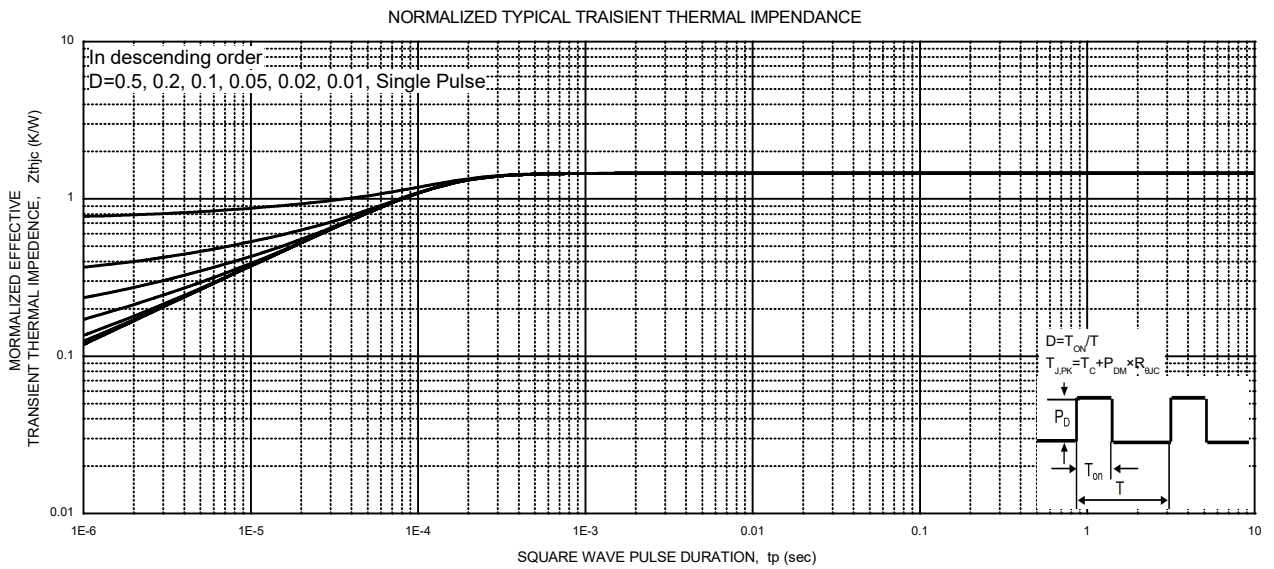
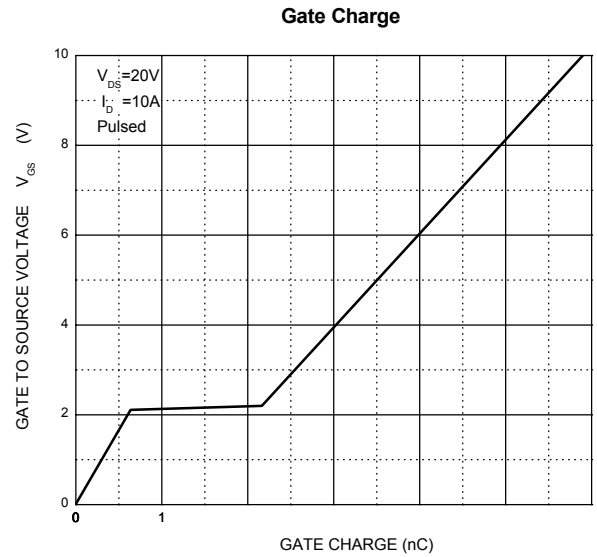
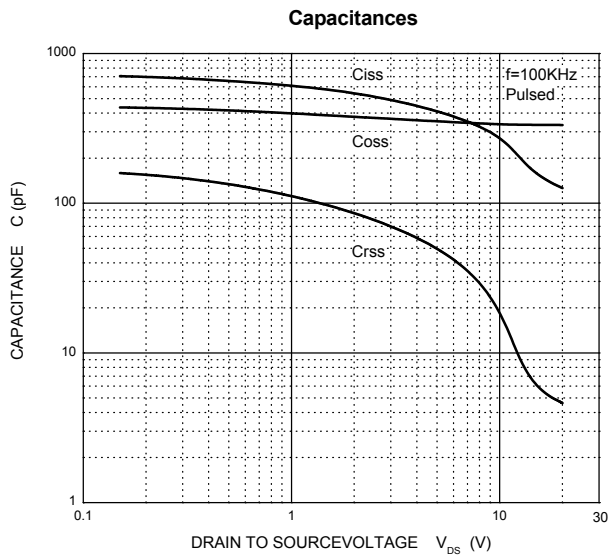

PDFNWB3.3x3.3-8L Package Outline Dimensions

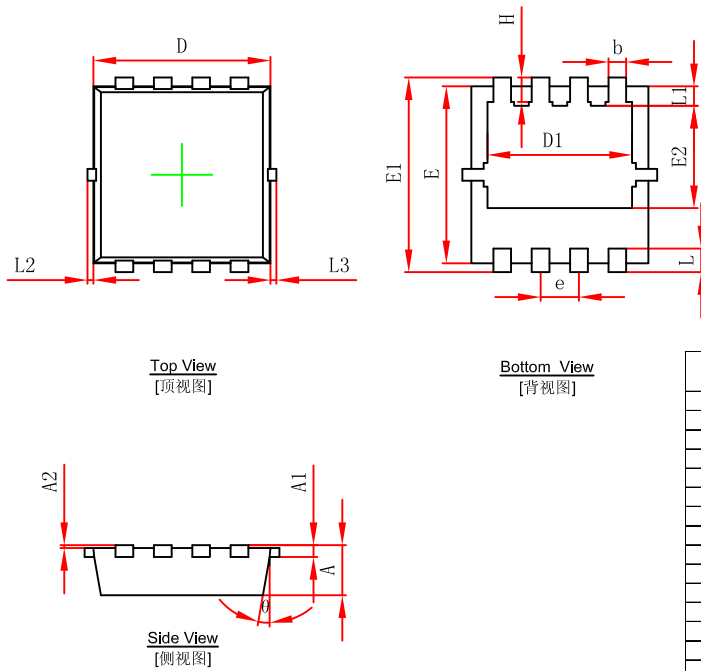

Symbol	Dimensions In Millimeters		Dimensions In Inches	
	Min.	Max.	Min.	Max.
A	0.650	0.850	0.026	0.033
A1	0.152 REF.		0.006 REF.	
A2	0~0.05		0~0.002	
D	2.900	3.100	0.114	0.122
D1	2.300	2.600	0.091	0.102
E	2.900	3.100	0.114	0.122
E1	3.150	3.450	0.124	0.136
E2	1.535	1.935	0.060	0.076
b	0.200	0.400	0.008	0.016
e	0.550	0.750	0.022	0.030
L	0.300	0.500	0.012	0.020
L1	0.180	0.480	0.007	0.019
L2	0~0.100		0~0.004	
L3	0~0.100		0~0.004	
H	0.315	0.515	0.012	0.020
θ	9°	13°	9°	13°

PDFNWB3.3x3.3-8L Suggested Pad Layout

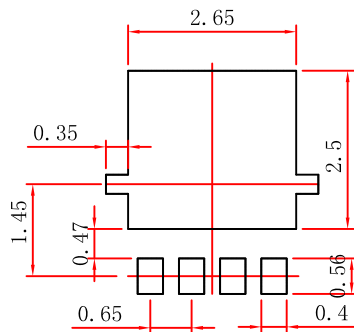

Note:

1. Controlling dimension: in millimeters.
2. General tolerance: $\pm 0.05\text{mm}$.
3. The pad layout is for reference purposes only.

PDFNWB3.3×3.3-8L Tape and Reel

PDFNWB3.3×3.3-8L Embossed Carrier Tape

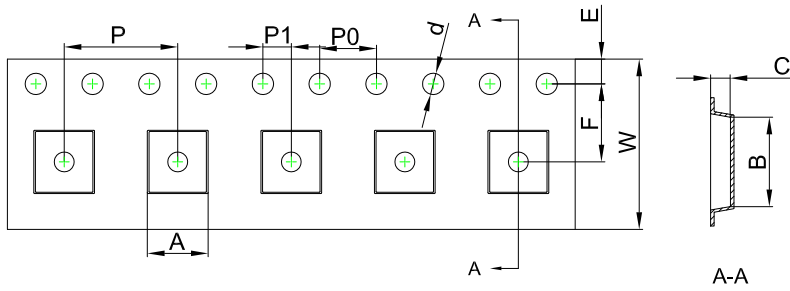

Packaging Description:
PDFNWB3.3×3.3-8L parts are shipped in tape. The carrier tape is made from a dissipative (carbon filled) polycarbonate resin. The cover tape is a multilayer film (Heat Activated Adhesive in nature) primarily composed of polyester film, adhesive layer, sealant, and anti-static sprayed agent. These reeled parts in standard option are shipped with 5,000 units per 13" or 33.0 cm diameter reel. The reels are clear in color and is made of polystyrene plastic (anti-static coated).

Dimensions are in millimeter										
Pkg type	A	B	C	d	E	F	P0	P	P1	W
PDFNWB3.3×3.3-8L	3.55	3.55	1.10	Ø1.50	1.75	5.50	4.00	8.00	2.00	12.00

PDFNWB3.3×3.3-8L Tape Leader and Trailer

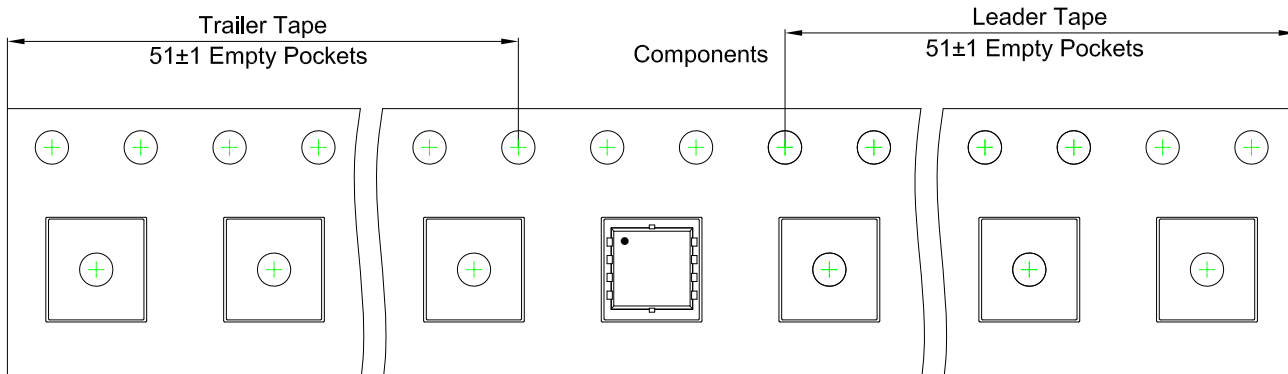

PDFNWB3.3×3.3-8L Reel

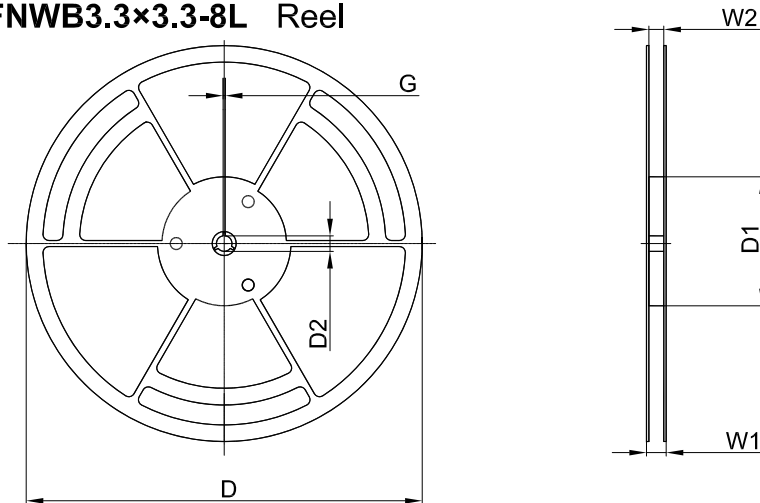

Dimensions are in millimeter						
Reel Option	D	D1	D2	G	W1	W2
13" Dia	Ø330.00	100.00	13.00	1.90	17.60	12.40

REEL	Reel Size	Box	Box Size(mm)	Carton	Carton Size(mm)
5,000 pcs	13 inch	5,000 pcs	340×336×29	50,000 pcs	353×346×365